



DT200 Series

Thermal Label Printer

User Manual **GODEX**

DT200 Series User Manual

P/N:920-018311-00

Version: A.1

Issue date:2021/10/15

CONTENTS

1 Thermal Label Printer	5
1.1 Box Content	5
1.2 Getting to know your printer	6
2 Printer Setup	9
2.1 Loading the label(The following uses the DT200iL series for explanation)	9
2.2 Switching label roll holder	13
2.3 Connecting the Printer to the Host Computer	14
2.4 Installing GoLabel	15
2.5 Installing the driver	18
3 Printer Setting and Control	22
3.1 Operation Panel Introduction	22
3.2 LED Status (DT200/DT200L Series)	23
3.3 Error Alerts	24
3.4 LCD Interface Introduction(DT200i/DT200iL Series)	25
3.5 LAN Setting(DT200i/DT200iL Series)	30
3.6 LCD Password (DT200i/DT200iL Series)	32
3.7 LCD Interface Function(DT200i/DT200iL Series)	34
3.8 Status of LCD Interface (DT200i/DT200iL Series)	37
3.9 Error Alerts (DT200i/DT200iL Series)	38
3.10 USB Host	40
4. NetSetting for Ethernet	42
4.1 Installing the NetSetting software	42
4.2 The Interface of NetSetting	43
5. Maintenance and Adjustment	50
5.1 Cleaning the Print Head	50
5.2 Troubleshooting	51
Appendix	52
DT200 series Printer Specification	52
Interface	54
File Mainpulation When Using USB Stick	55

FCC COMPLIANCE STATEMENT

FOR AMERICAN USERS

This equipment is in accordance with the procedures are given in ANSI C63.4-2014 and the energy emitted by this equipment was **Passed by CISPR PUB. 22,**

FCC Part 15 Subpart B, Canada Standard ICES-003 Issue6.

Radiated and conducted emissions are compliance in **Class B** limits.

EMS AND EMI COMPLIANCE STATEMENT

FOR EUROPEAN USERS

This equipment is in accordance with the procedures are given in EUROPEAN COUNCIL DIRECTIVE 2014/30/EU. The equipment was Passed the test performed according to European Standard EN 55032:2015/AC:2016 Class B,

EN 61000-3-2:2014,EN61000-3-3:2013 and EN55024:2010/A1:2015

(IEC 61000-4-2 Edition 2.0 2008-12,IEC 61000-4-3 Edition 3.2 2010-04,

IEC61000-4-4 Edition 3.0 2012-04, IEC 61000-4-5 Edition 3.0 2014-05,

IEC61000-4-6 Edition 4.0 2013-10,IEC 61000-4-8 Edition 2.0 2009-09,

IEC 61000-4-11 Edition 2.0 2004-03) and

Australian Standard AS/NZS CISPR 32:2015 Class B.

SAFETY INSTRUCTIONS

Please read the following instructions carefully.

1. Keep the equipment away from humidity.
2. Before you connect the equipment to the power outlet, please check the voltage of the power source.
3. Make sure the printer is off before plugging the power connector into the power jack.
4. It is recommended that you connect the printer to a surge protector to prevent possible transient overvoltage damage.
5. Be careful not to get liquid on the equipment to avoid electrical shock.
6. For safety and warranty reasons, ONLY qualified service personnel should open the equipment.
7. Do not repair or adjust energized equipment under any circumstances.
8. Before disassemble the cutter, please turn off the power and wear the gloves on.



Hot parts!

Burned fingers when handling the parts

Wait one-half hour after switching off before handling parts.



The blade is sharp, please do not touch.

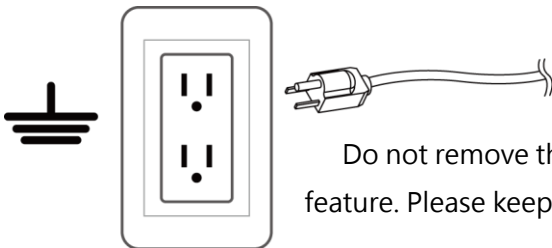

Do not remove the ground pin of power cord. Grounding is an important safety feature. Please keep the power cord grounded all the time

Caution

- Danger of explosion if battery is incorrectly replaced. Replace only with the equivalent type recommended by the manufacturer.
- Dispose of used batteries according to the manufacturer's instructions.
- Only use with designated power supply adapter model.
- Changes or modifications not expressly approved by the party responsible for compliance could void the user's authority to operate the equipment.

Specifications are subject to change without notice.

1 Thermal Label Printer

1.1 Box Content

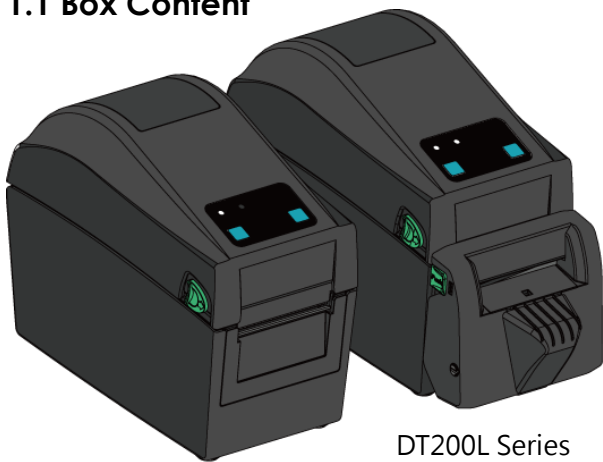

DT200 Series

DT200L Series



DT200iL Series

DT200i Series

- Power cord



- USB cable



- Power adapter

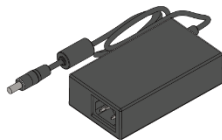

- *Peel detection board

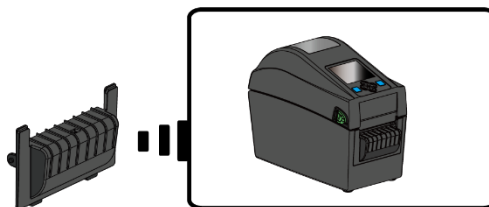

- DT200 Quick guide

*Only for DT200L/DT200iL Series

※Package content and Logo style may vary per region.

1.2 Getting to know your printer

Front View

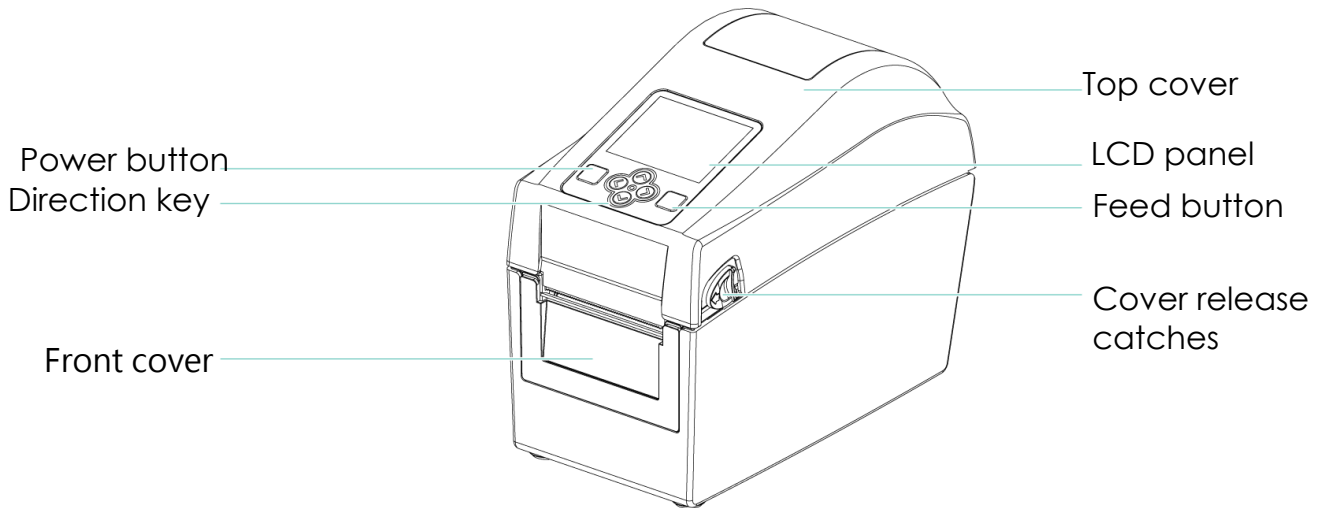

Rear View

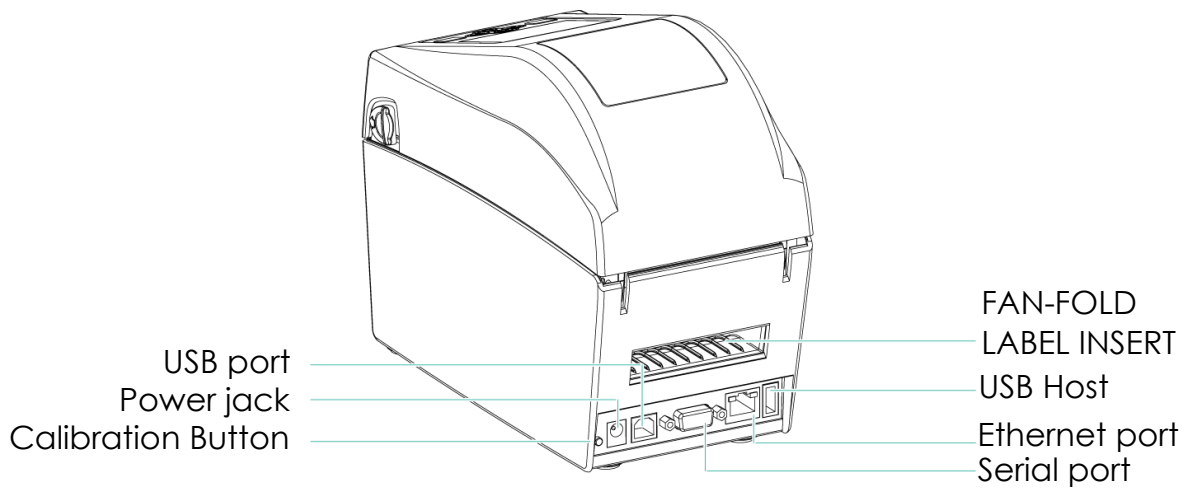

Bottom View

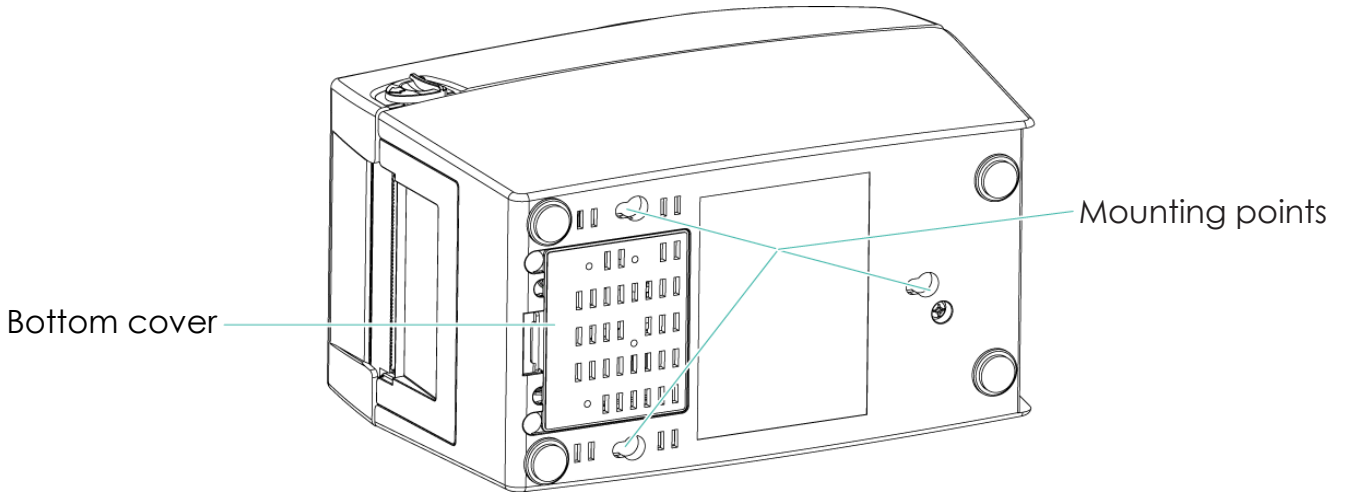

※Specifications of the wall-mounted screws.

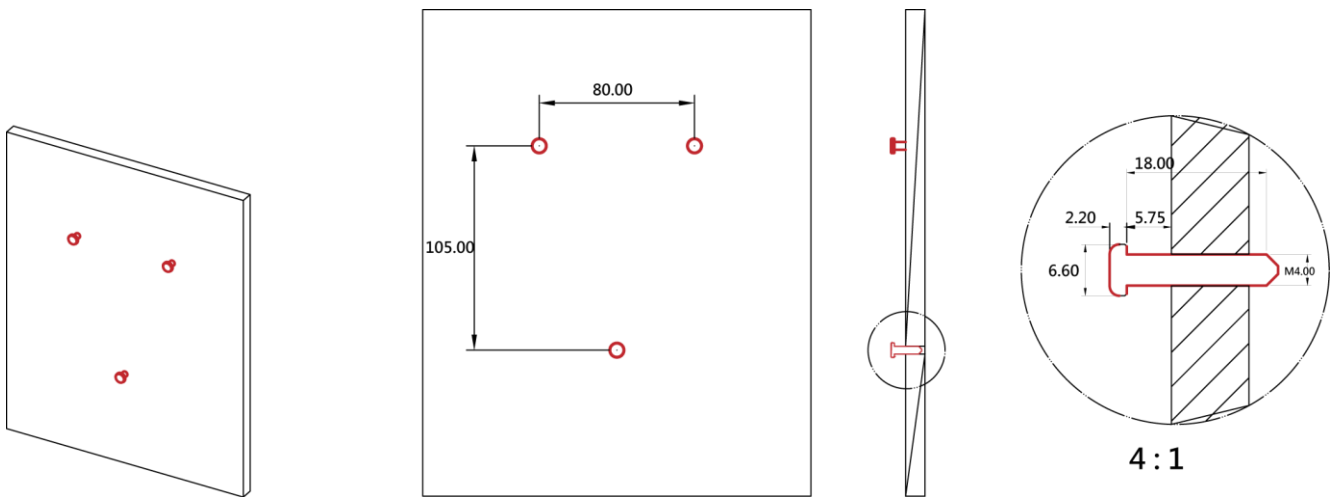

The Internal view of printer

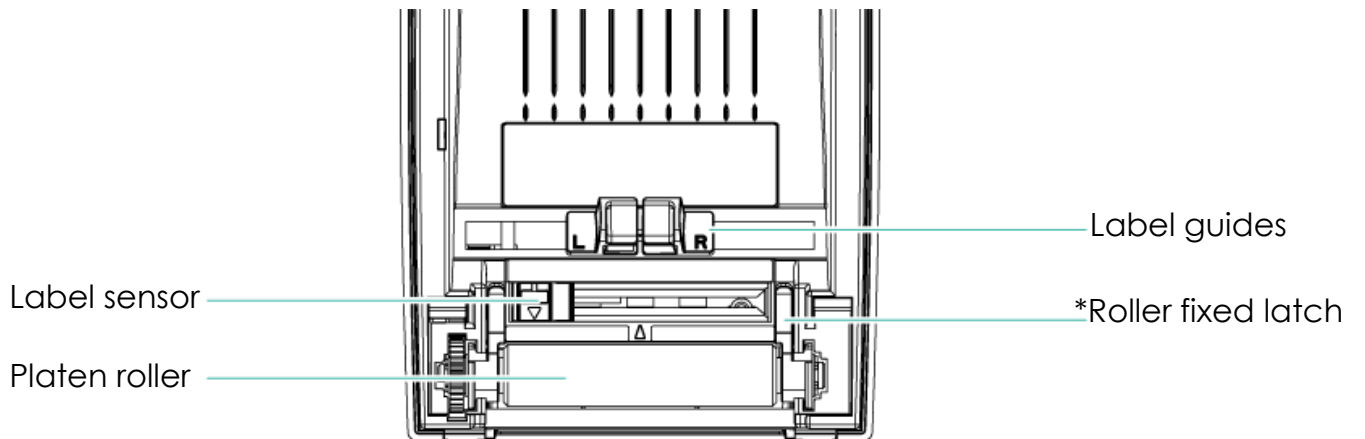
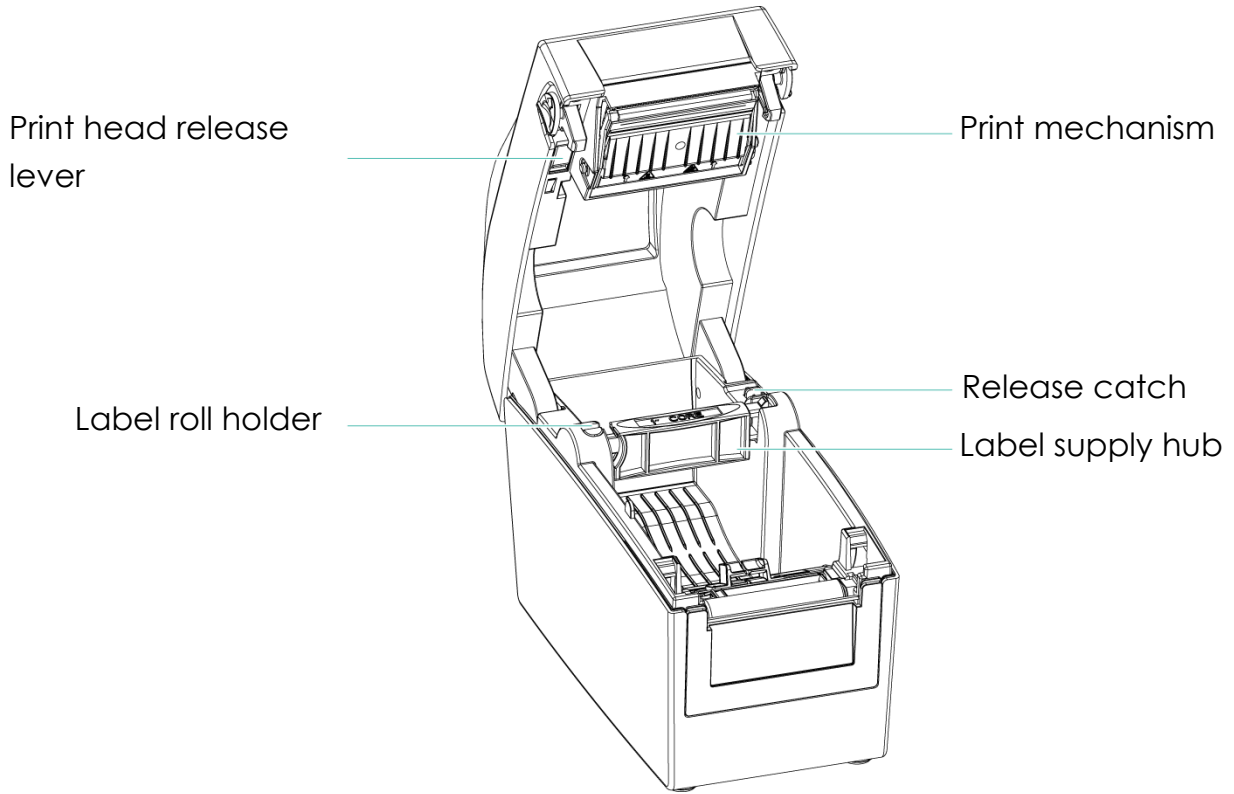

2 Printer Setup

2.1 Loading the label(The following uses the DT200iL series for explanation)

1. Place the printer on a flat surface and open the printer cover.

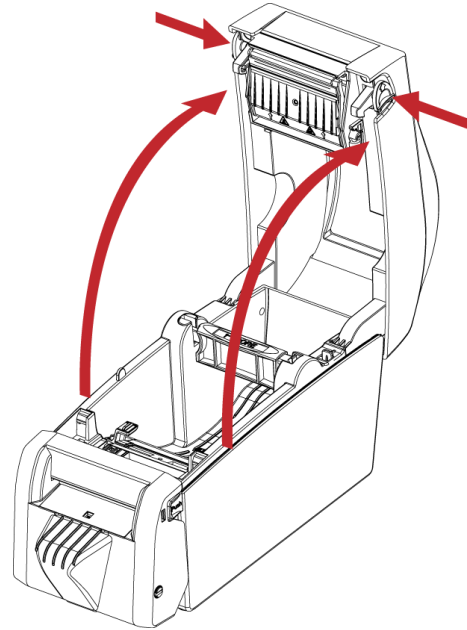

2. Release the label supply hub.

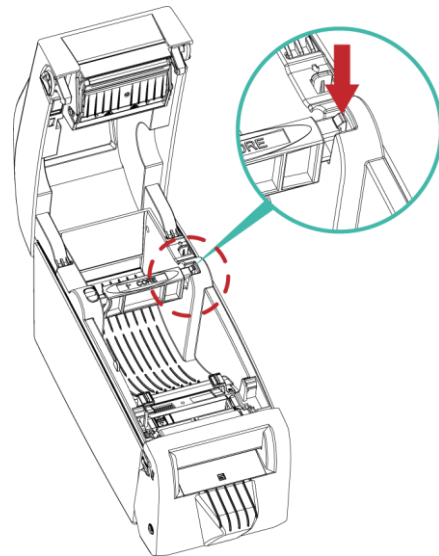

3. Lift the label roll holder and pull it out as far as possible.

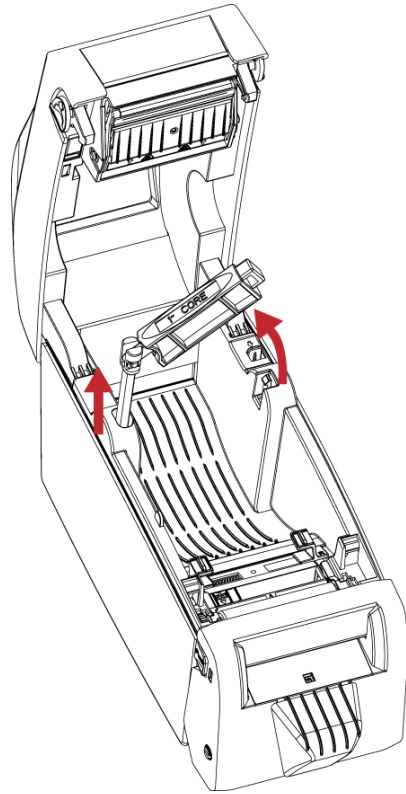

4. Install the label roll on the label supply hub.

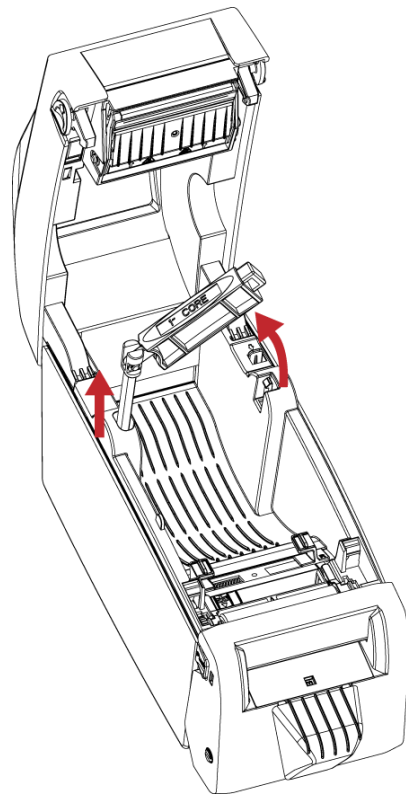

5. Now press the label roll holder down until it clicks into place.

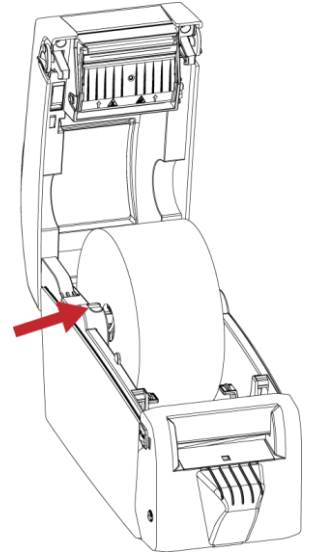
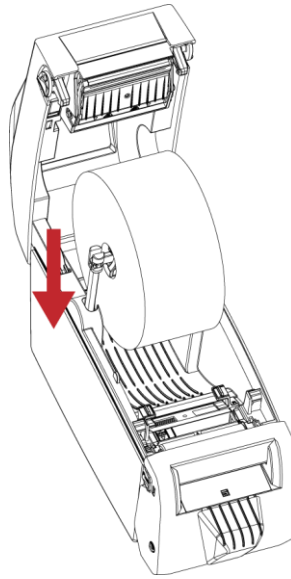

6. Pass the label under the paper guides and pull it forward.

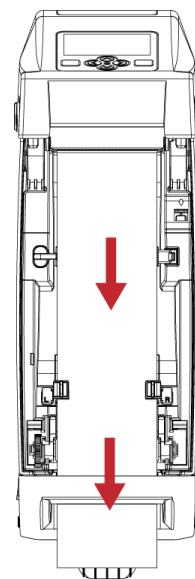
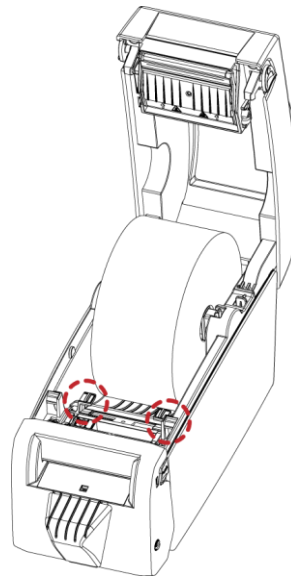

7. Adjust the paper guides to the width of the label liner.

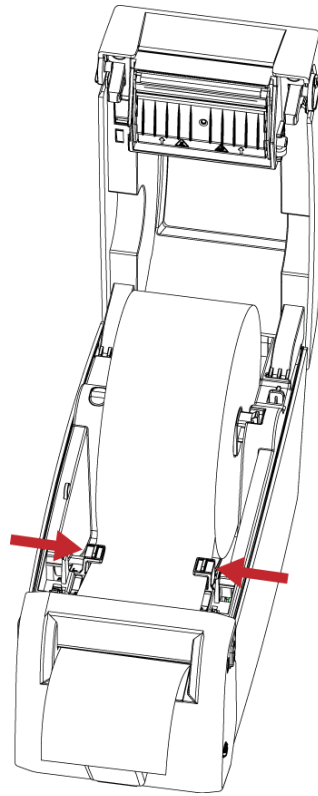

8. Close the printer cover to finish loading the labels

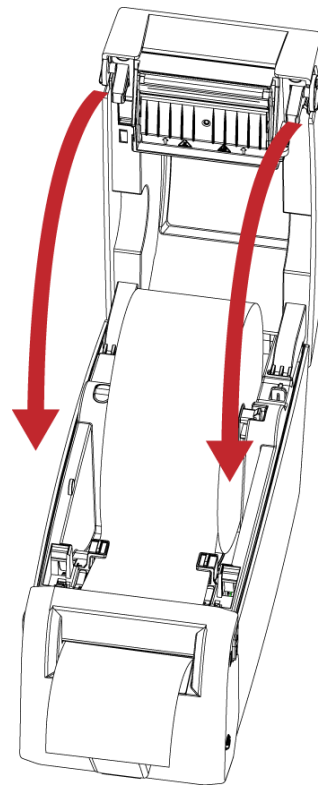

2.2 Switching label roll holder

1. Pull the label roll holder out as far as it will go.

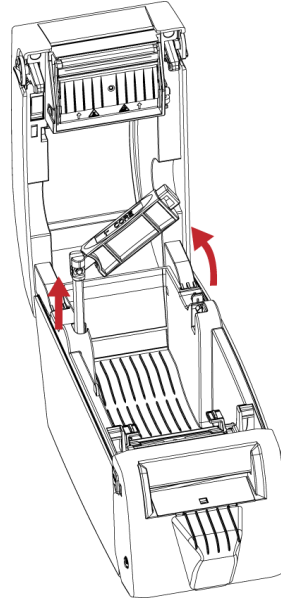

2. Fold out the label supply hub as shown in the illustration.

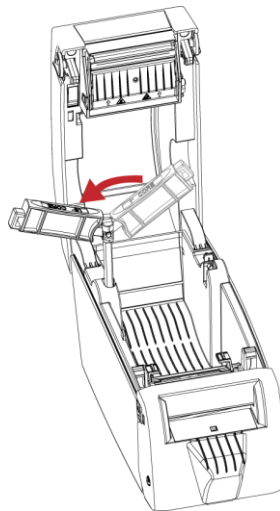

3. Now rotate the label roll holder to return the label supply hub to its original position.
Press down the label supply hub until it clicks into place.

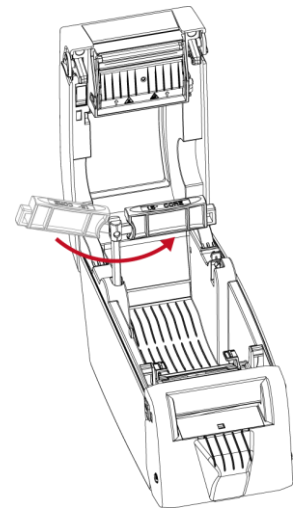

*If the label supply hub is not pulled all the way up, the label supply hub will not rotate.

2.3 Connecting the Printer to the Host Computer

1. Please make sure that the printer is switched off.
2. Connect the power cord to the AC adapter and connect the adapter to the printer.
3. Connect the USB cable to the printer and host computer.
4. Switch on the printer. The operator panel should now light up.

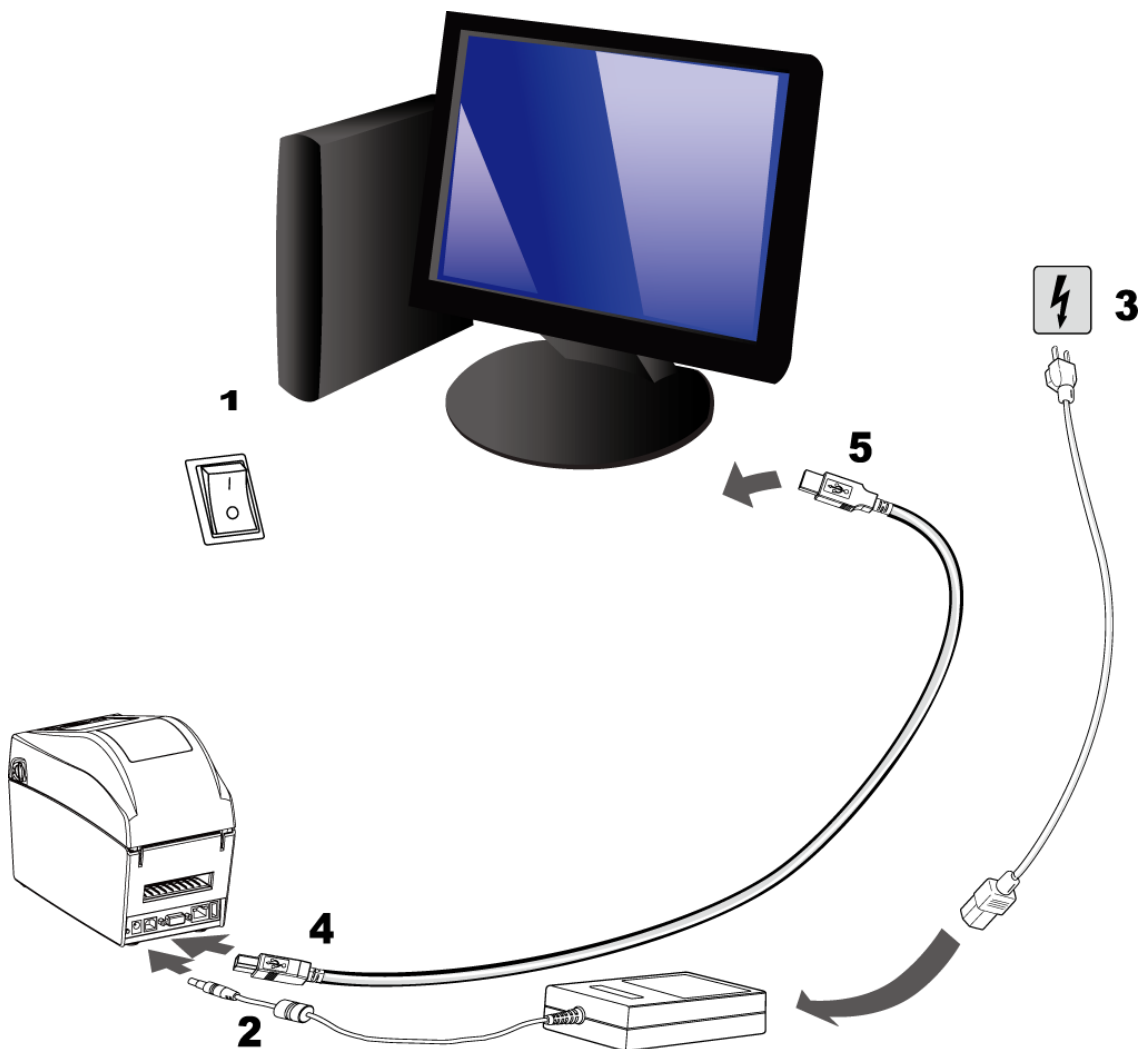

2.4 Installing GoLabel

Related documents and software can be downloaded from the official website

1. Click the installer in the folder to install.

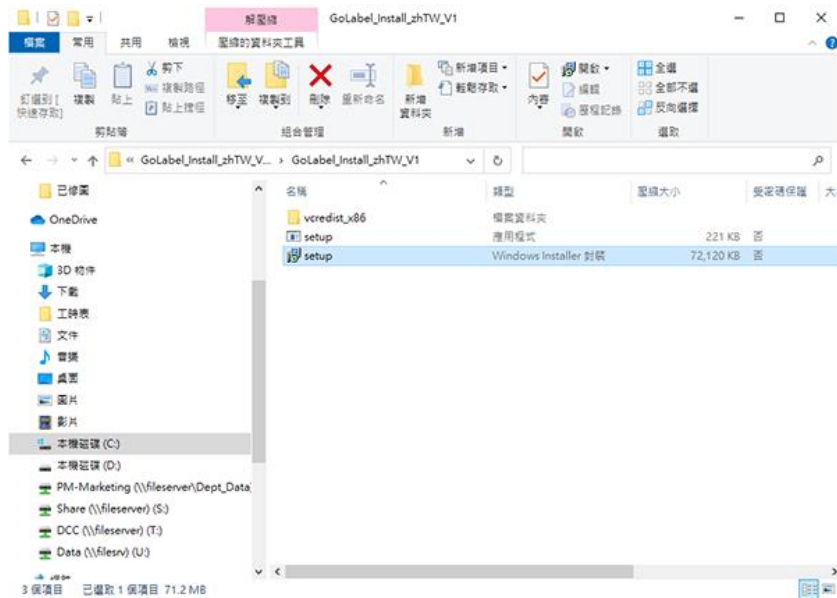

2. After entering the installation screen, click "Next".

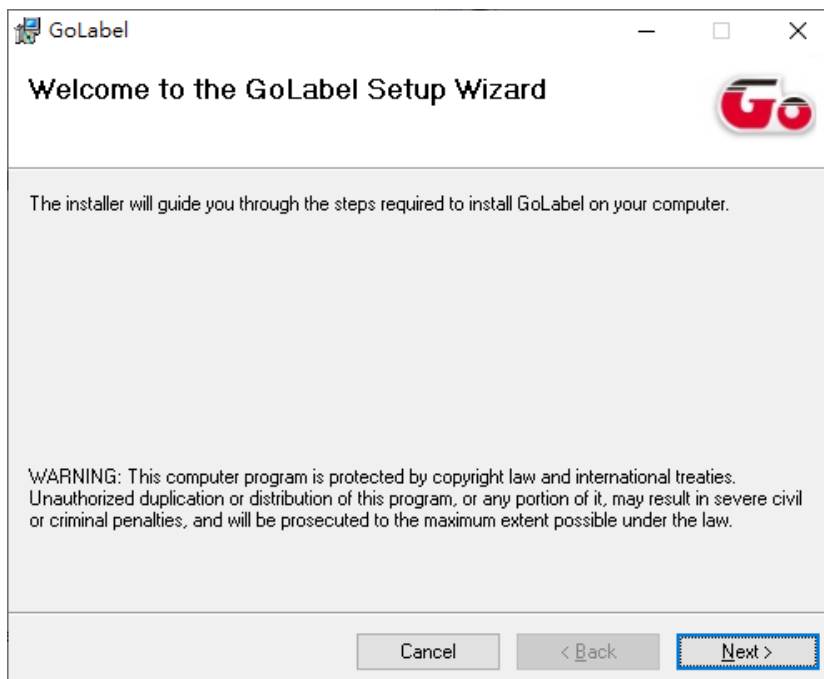

3. After selecting the folder to install, click "Next"

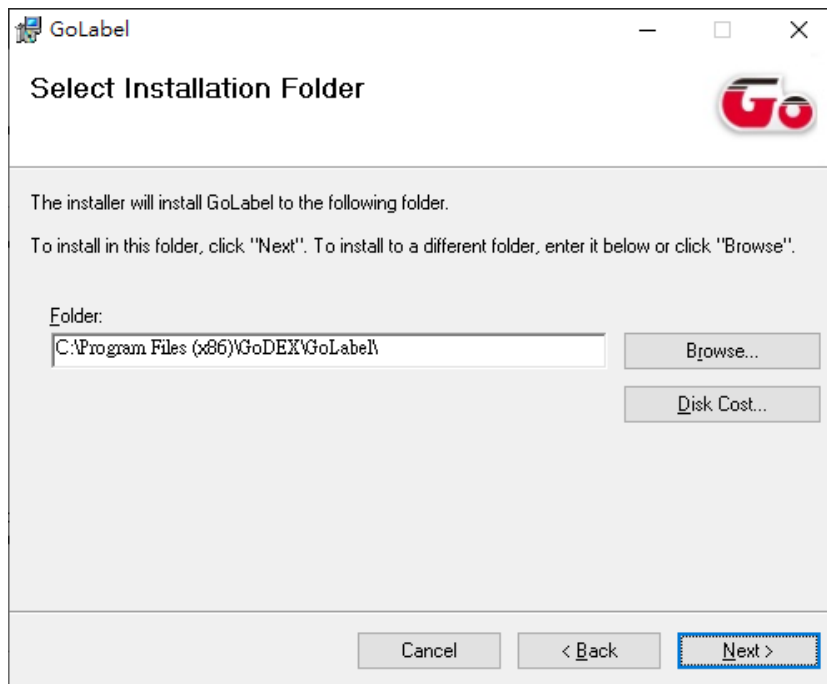

4. Click Next to start the installation.

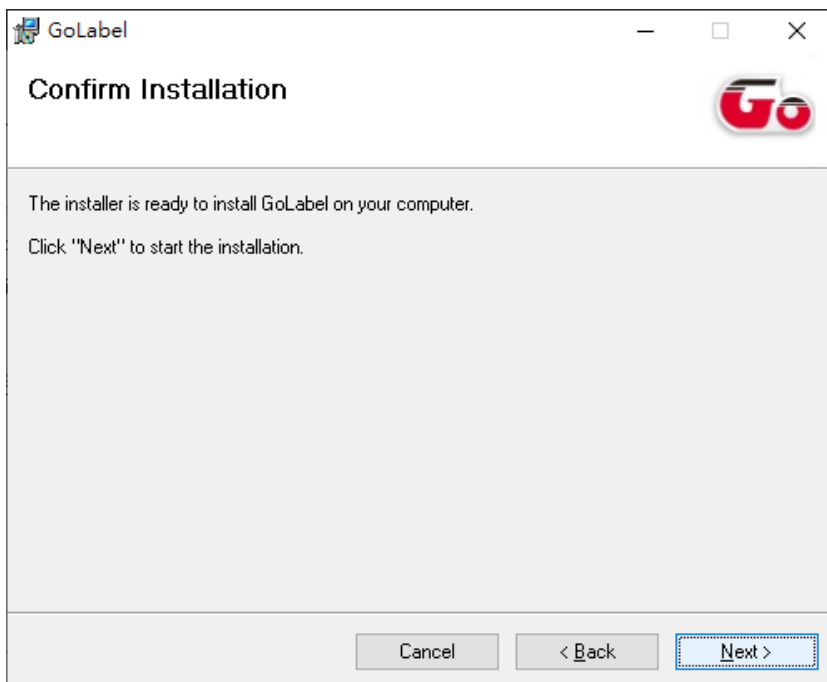

5. Finish installation

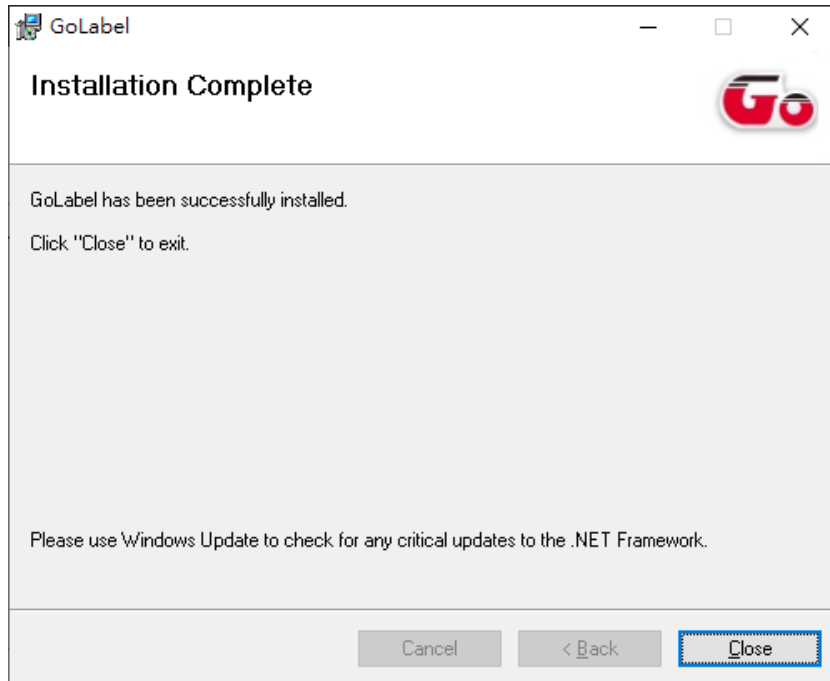

2.5 Installing the driver

1. Click the compressed driver file in the folder.

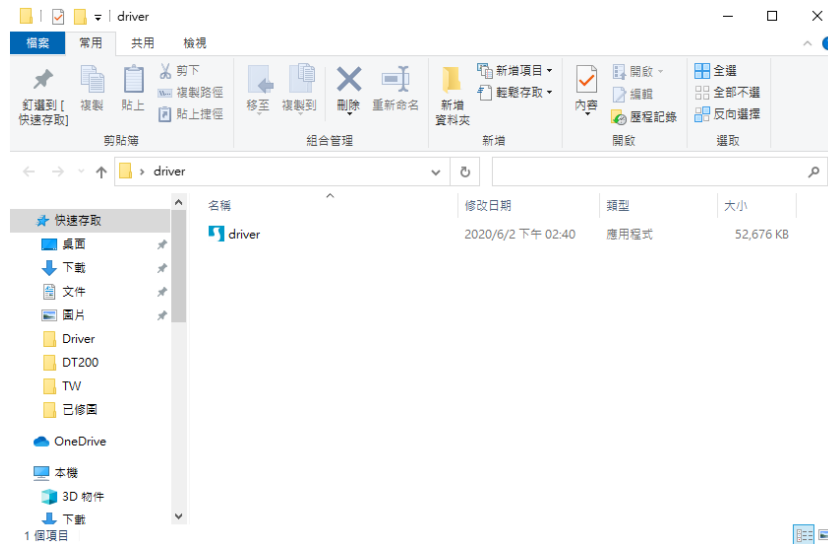

2. Select "I accept the terms in the license agreement." and click "Next".



3. Select the path to unzip and click "Next"

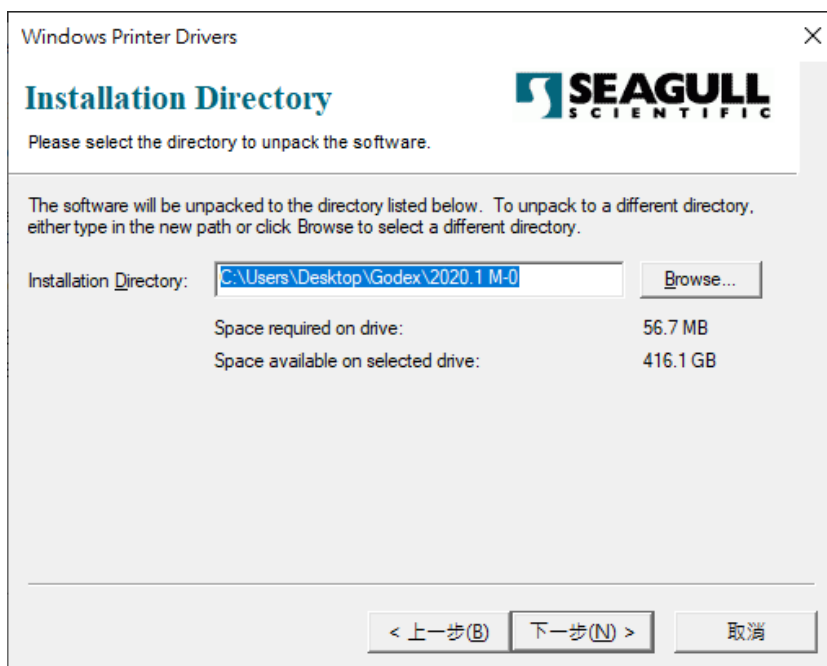

4. Click "Finish" and open the Driver Wizard

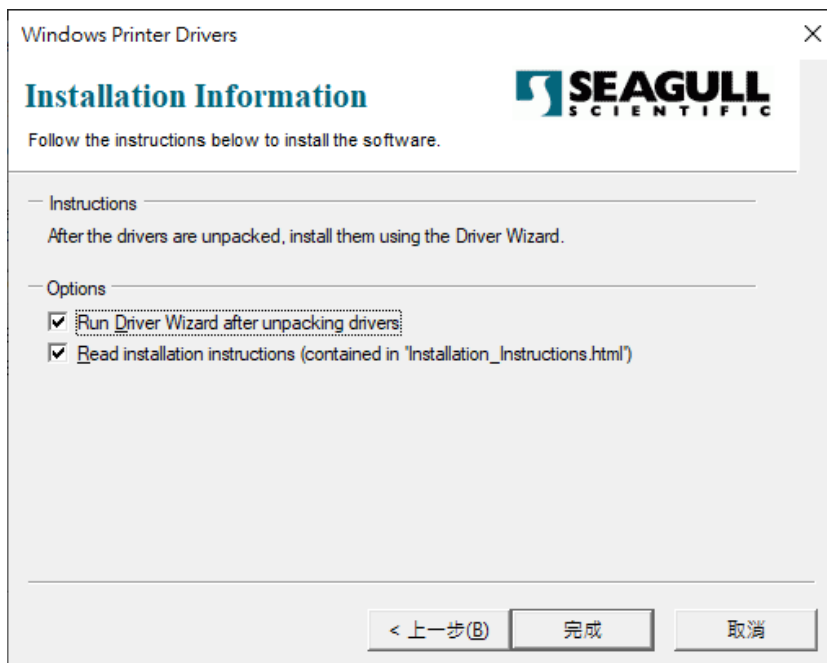

5. The driver installation wizard will automatically detect the model, please click "Next" to start the installation.

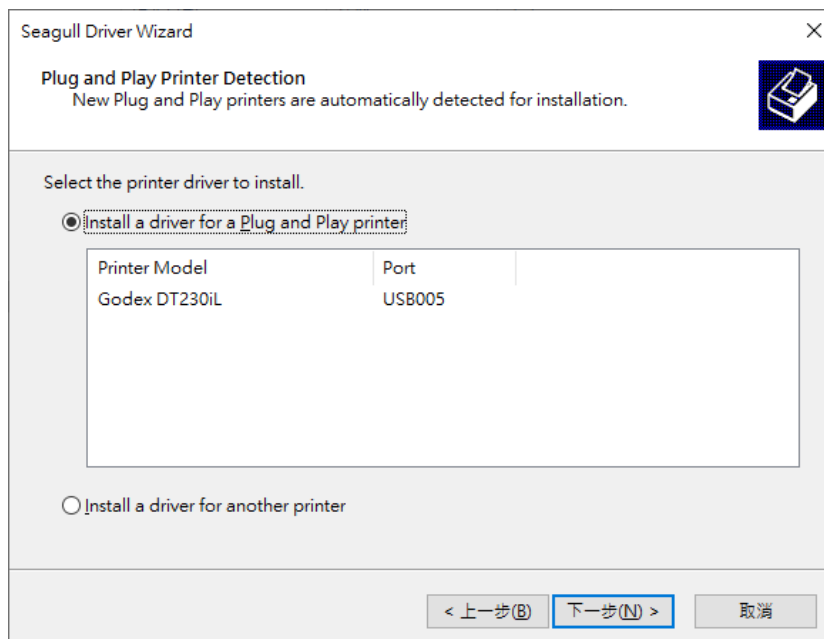

6. After entering the printer name, click "Next"

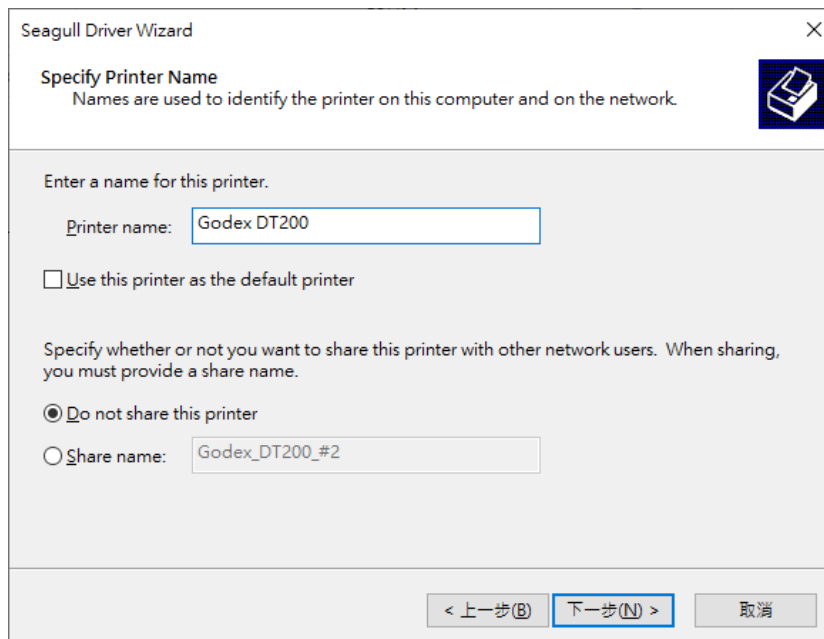

7. After confirming the settings, click "Finish" to install.

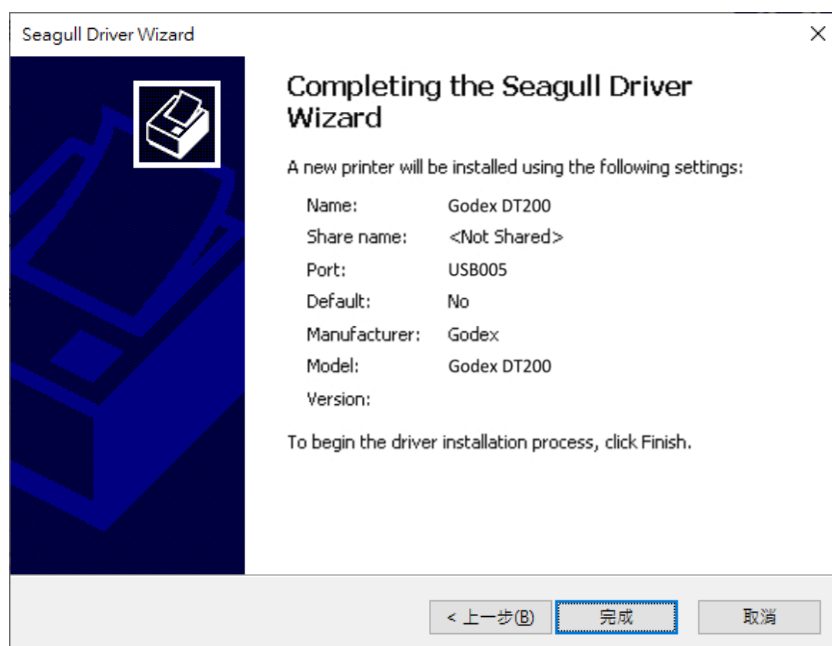

3 Printer Setting and Control

3.1 Operation Panel Introduction

POWER Button

Press the POWER button and the LED indicator lights up green. The printer is on “ Ready to print “ status now.

When printer is turned on, keep pressing the POWER button for 3 seconds will turn the printer off.

FEED Button

When you press the FEED button, the printer moves the label to the defined stop position.

If you are using continuous labels, pressing the FEED button will move label stock until you release the button again.

If you are using individual labels, pressing the FEED button will move only one label.

PAUSE PRINTING_FEED Button

Pressing the FEED button during printing will interrupt printing. When the PFEED button is pressed again, the printer resumes printing. Example: While a 10-label print job is running, you press the FEED button to pause the printer.

Two of the labels have been printed. To resume printing and print the remaining eight labels, you press the FEED button again.

CANCEL PRINTING_FEED Button

Pressing the FEED button over 3 seconds during printing cancels a print job. The current print job is cancelled.

Example: While a 10-label print job is running, you press the FEED button. Two of the labels have been printed.

The print job is cancelled and the remaining eight labels are not printed.

3.2 LED Status (DT200/DT200L Series)

Press the FEED button and keep it pressed, then switch on the printer. You will hear two beeps and the LED lights up red.

Release the FEED button. The printer will now automatically measure the label size and then print a test page

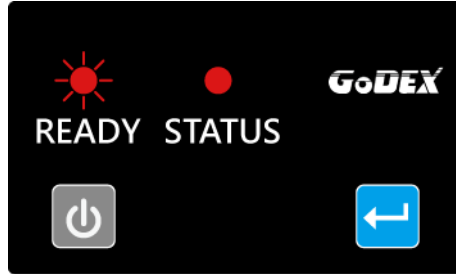

LED Indicator	READY	STATUS
		Red flashing

The contents of a self-test printout are listed below.

Model & Version	DT230:VX.XXX
USB ID setting	USB S/N:12345678
Serial port setting	Serial port:96,N,8,1
MAC address of Ethernet port	MAC A ddr:xx-xx-xx-xx-xx-xx
IP protocol setting	DHCP Enable
IP address of Ethernet port	IP xxx.xxx.xxx.xxx
Gateway setting	Gateway xxx.xxx.xxx.xxx
Netmask setting	Sub-Mask xxx.xxx.xxx.xxx
	#####
Number of DRAM installed	1 DRAM installed
Image buffer size	Image buffer size:1500 KB
Number of forms	0000 FORM(S) IN MEMORY
Number of graphics	0000 GRAPHIC(S) IN MEMORY
Number of fonts	000 FONT(S) IN MEMORY
Number of Asian fonts	000 ASIAN FONT(S) IN MEMORY
Number of Databases	000 DATABASE(S) IN MEMORY
Number of Scalable fonts	000 TTF(S) IN MEMORY
Free memory size	4073 KB FREE MEMORY
Speed, Density, Ref. Point, Print direction	^S4 ^H8 ^R000 ~R200
Label width, Form length, Stop position	^W102 ^Q100,3 ^E18
Cutter, Label Dispenser, Mode	Option: ^D0 ^O0 ^AD
Sensor Setting	Reflective AD:1.96 2.84 2.49[0.88_23]
Code Page	Code Page:850



3.3 Error Alerts

In the event of a problem that prevents normal functioning of the printer, you will see an error message on LED indicators and hear some beep signals. Please refer to below table for the error alerts.





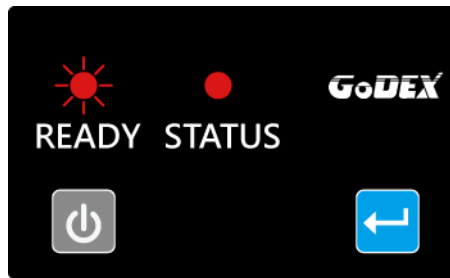

Error Light

- Red 

Flashing Frequency

- Flashing 
- Light on 



READY LED	STATUS LED	Type	Beeps	Description	Solution
		Print Head Error	2*4 beeps	The printing mechanism is not correctly closed.	Open the print mechanism and close it again.
		Print Head Error	None	High temperature at the print	Once the print head has cooled down, the printer switches to standby mode.
		Media Error	2*3 beeps	No need ribbon installed and printer Display error.	Make sure that the printer is set to direct thermal printing mode.
		Media Error	2*2 beeps	No paper is detected.	Make sure that the label sensor is positioned correctly. If the sensor still does not detect the paper, run the auto-detection function again.
	Paper is finished.			Replace the label roll.	
	Printer feed problem.			Possible reasons: the print medium has become trapped around the rubber roll; the sensor cannot detect a gap or black mark between the labels; there is no paper. Please reset the sensor.	
		File Error	2*2 beeps	The memory is full. The printer prints the message "File System full".	Delete unnecessary data or install additional memory.
	Unable to find file. The printer prints the message "File Name Not Found".			Use the "~X4" command to print all files. Then check whether the files exist and whether the names are correct.	
	A file of the same name already exists. The printer prints the message "Duplicate Name".			Change the name of the file and try storing it again.	

3.4 LCD Interface Introduction(DT200i/DT200iL Series)

Getting Started

Press the POWER button to turn on the printer, and the START UP SCREEN appears.



If the printer is on “ready to print” status, the LCD screen should display the message “Ready” on the screen.

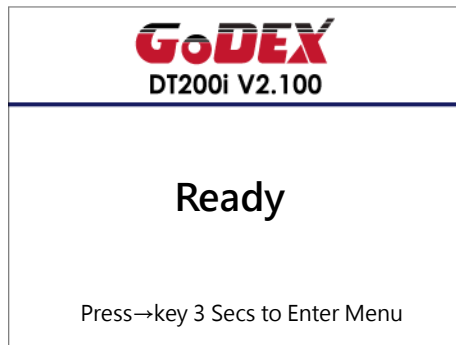

Please keep pressing → button and wait for the timer to be filled, then the LCD interface will enter into the MAIN PAGE for SETTING MODE. You can make various setting functions in SETTING MODE.

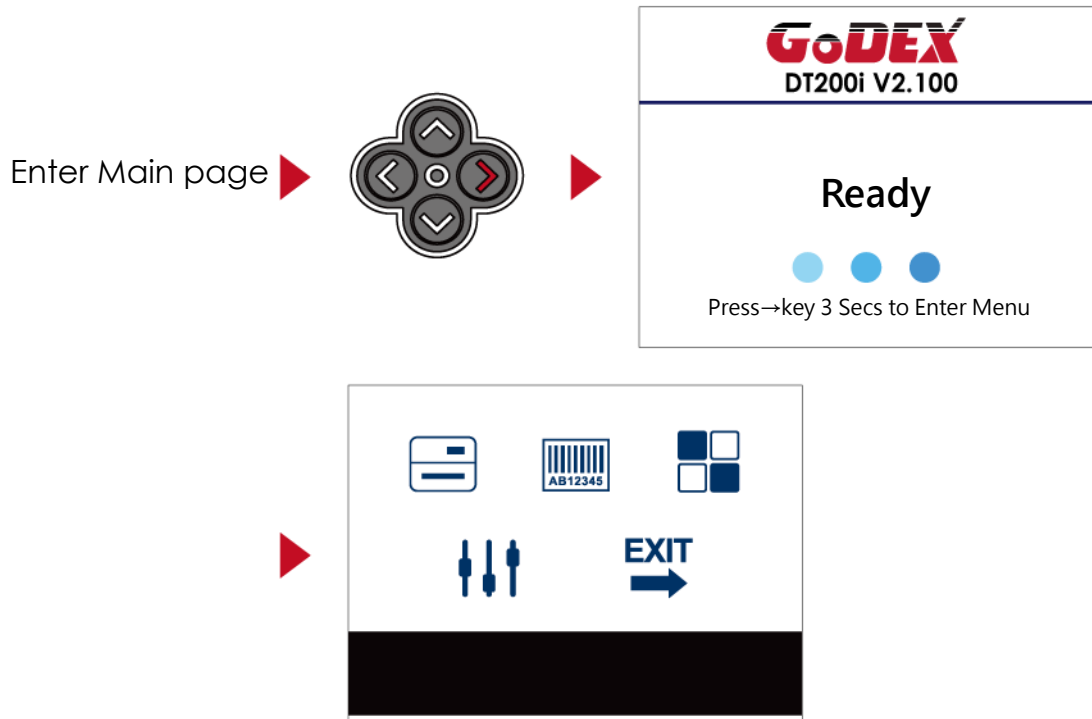

Operations on Setting Page

On MAIN PAGE, press → or ← button to move the cursor and select the functions.

Select a designated function and press FEED button, you will enter the SETTING PAGES for the function.

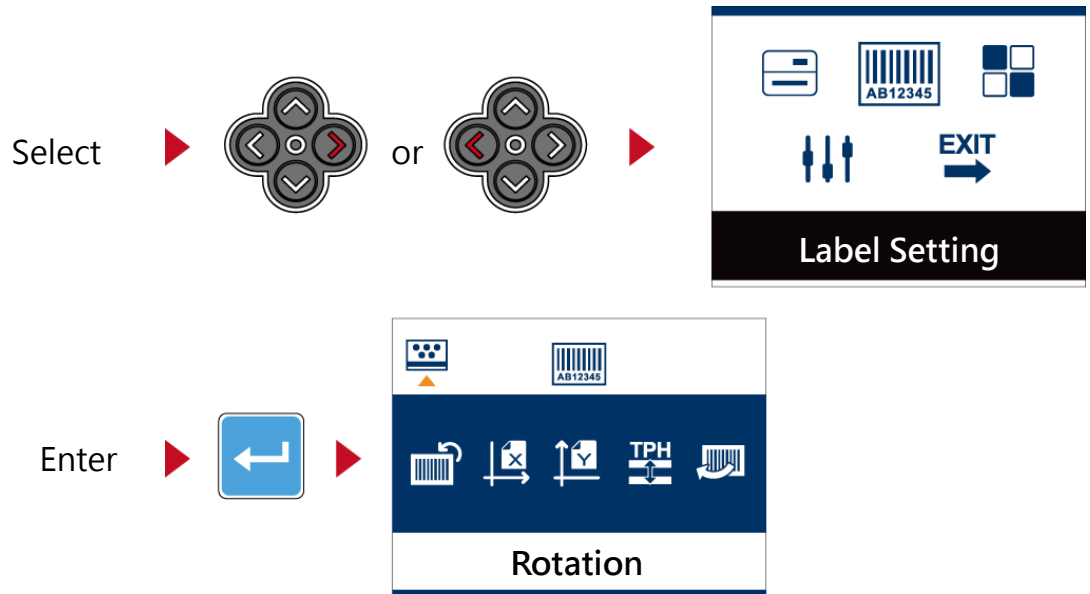

On SETTING PAGES, press → or ← button to select the setting items.

Select a designated function and press FEED button, you will enter the SETTING VALUE PAGES for the function

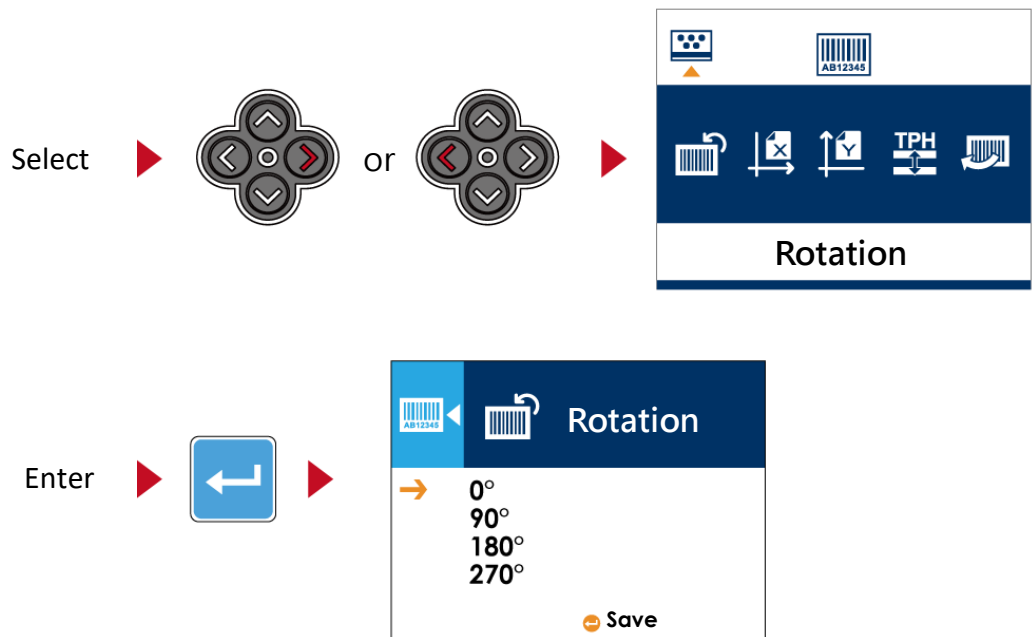

On SETTING VALUE PAGES, press \uparrow or \downarrow button to change the setting values.



Press FEED button will apply the setting value you just selected, and the red tick will appear to mark the value.

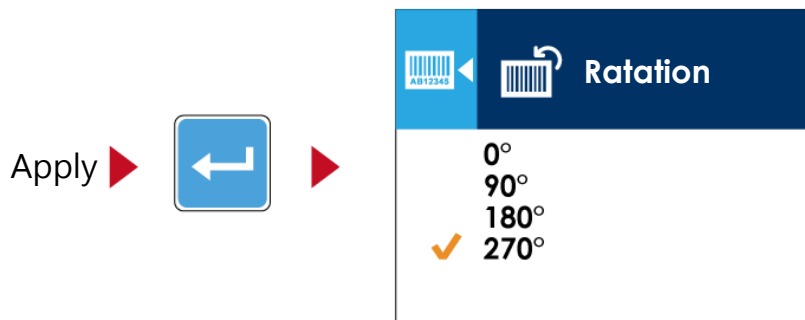

Notice

- The blue arrow indicates the value you are selected.
- The red tick indicates that the selected value is applied now.



Exit from Current Page to Ready Status

The icon on top-left corner displays the capture of upper level screen and also guides you back to upper level with left or up arrow.

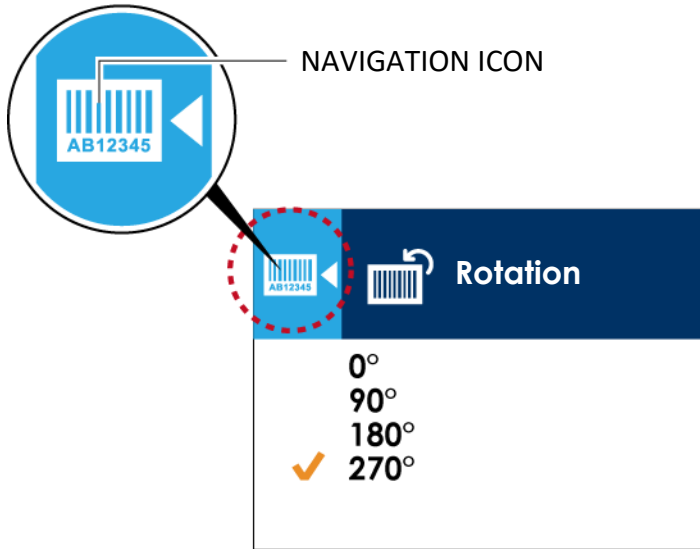

On SETTING VALUE PAGES, press ← button will go back to the upper level screen.

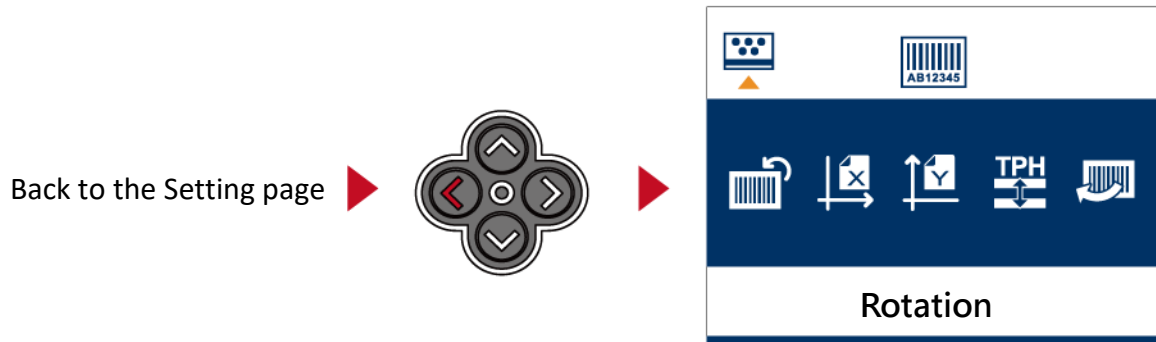

On SETTING PAGES, press ↑ button will go back to the MAIN PAGE screen.



On MAIN PAGE, select the "EXIT" icon and press the FEED button to exit from SETTING MODE and the printer goes back to READY status.

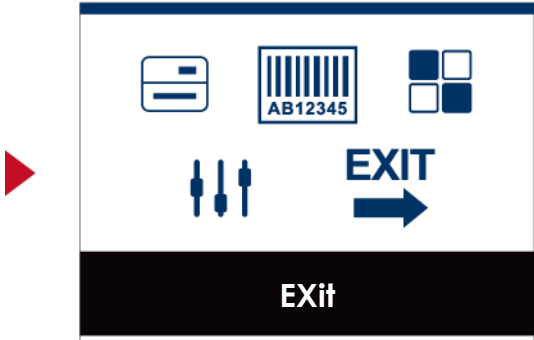
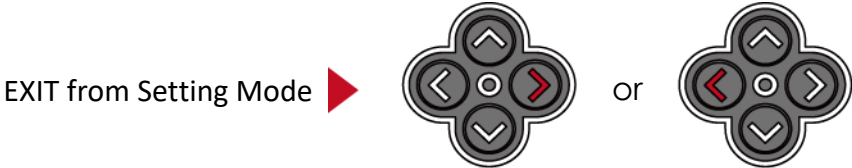

3.5 LAN Setting(DT200i/DT200iL Series)

Operations on Setting Page

On MAIN PAGE, press → or ← button to move the cursor and select the functions.

Select a designated function and press FEED button, you will enter the SETTING PAGES for the function

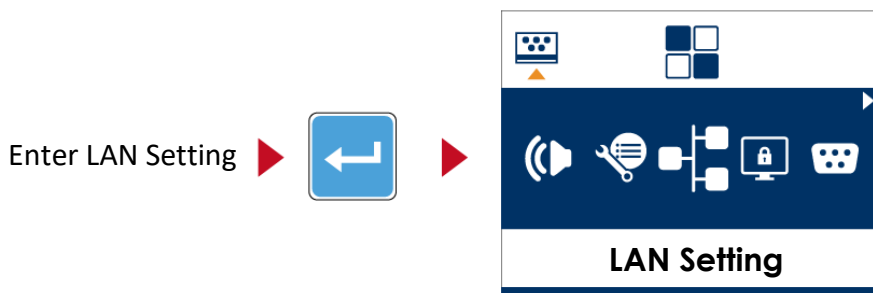
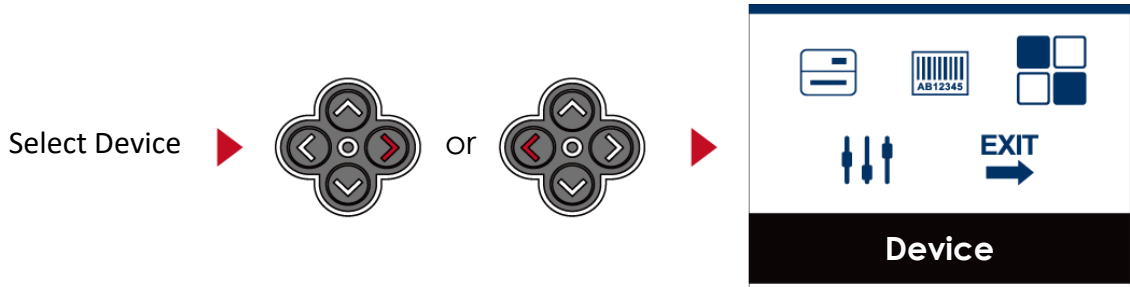

On LAN Setting PAGE, press → or ← button to select the setting items.

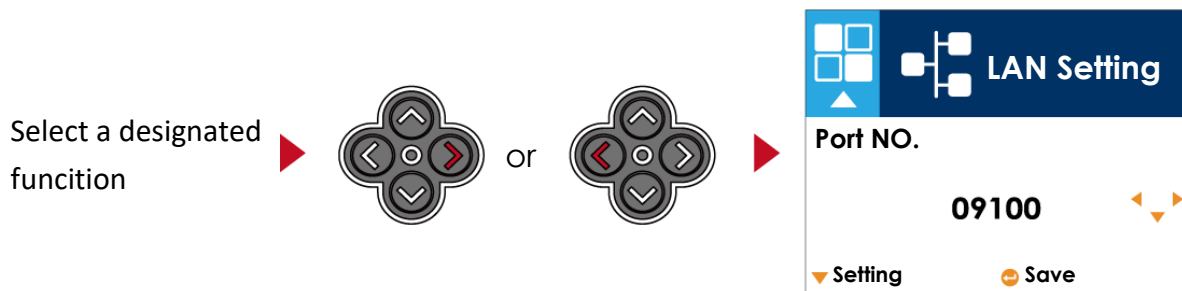

Select DHCP and press FEED button, you will be able to setup DHCP function

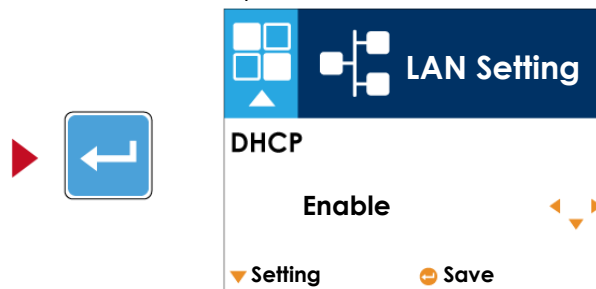

The default of DHCP is Disable. Press ↑ or ↓ button to change the setting values

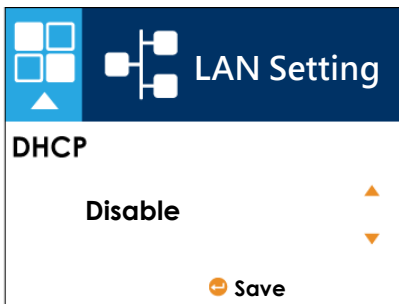

Select ↓ to enable DHCP

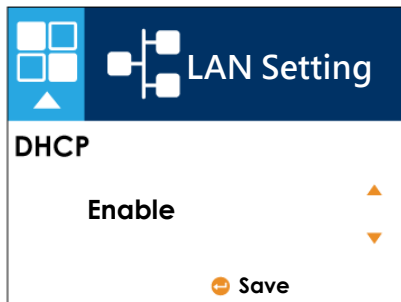

Press FEED button twice to save the setting.

Press FEED once to exit.

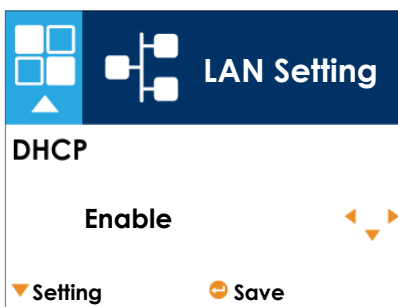

Press FEED again to save and return to previous SETTING PAGE

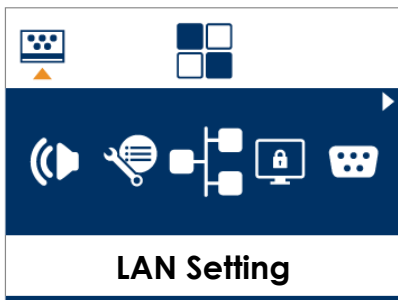

3.6 LCD Password (DT200i/DT200iL Series)

Operations on Setting Page

On MAIN PAGE, press → or ← button to move the cursor and select the functions. Select a designated function and press FEED button, you will enter the SETTING PAGE for the function.

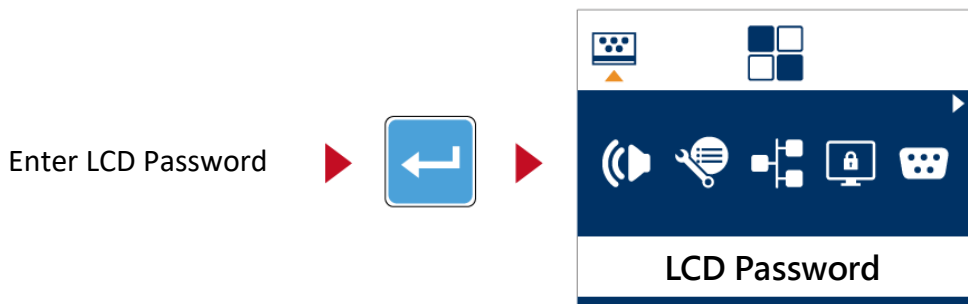
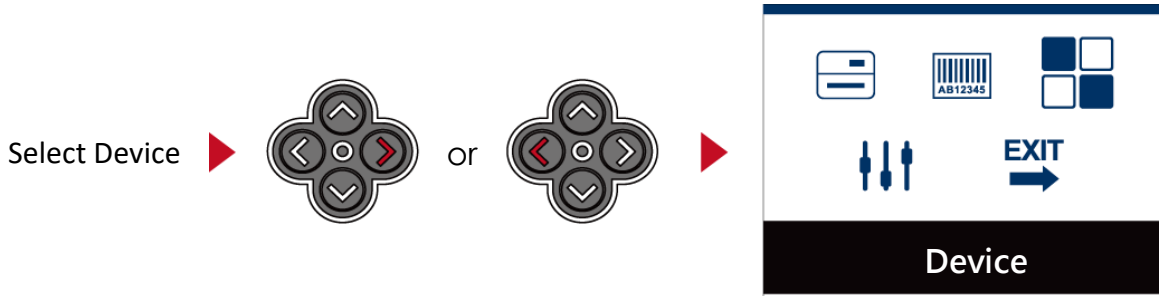

The default of LCD Setting is Disable. Press ↑ or ↓ button to change the setting values.

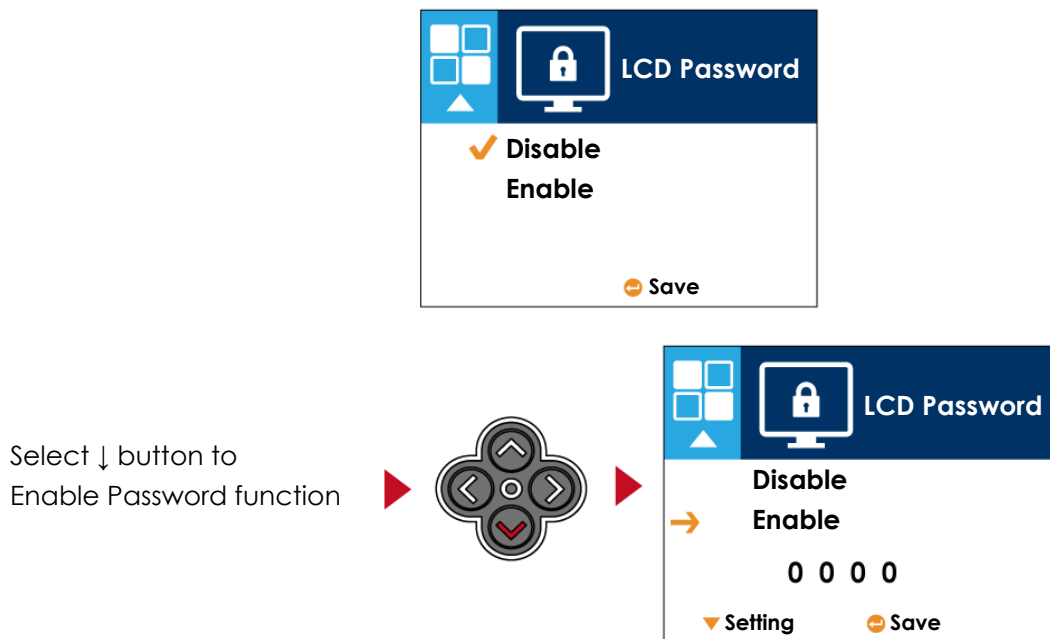

Select ↓ button again to setup the password

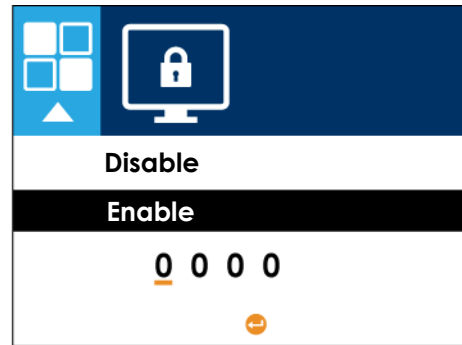

Press FEED button twice to save the setting.

Press FEED button once to exit.

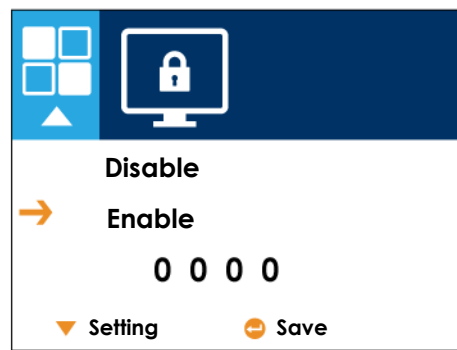

Press FEED button again to save and return to previous SETTING PAGE



3.7 LCD Interface Function(DT200i/DT200iL Series)

Main Page

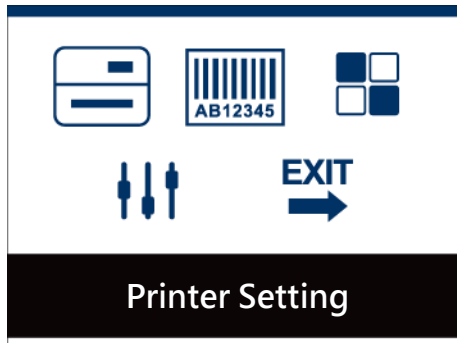

Setting items for printer, ex. Printing speed, darkness.
Also includes a Printing Wizard for your ease of printing.



Setting items for printing label, ex. Rotation, Printing position offset.



Option modules and connection port settings



Self-Diagnose functions for printer, ex. TPH testing, self-test page printing.



Exit from Setting Mode.

Setting Items in Setting Mode



Printer Setting

		English
	LCD Language	German
		繁體中文
		简体中文
	Speed	2-7
	Darkness	0-19
Wizard	Media Type	Label with gaps
		Label with Marks
		Continuous
	Printer Mode	Direct Thermal
		Thermal Transfer
	Tear-off Position	0-40
	Darkness	0-19
	Speed	2-7
	Sensor	Media Detection
		Auto Select
		See-Through
		Reflective
		Label with gaps
		Label with marks
		Continuous
	Printing Mode	Direct Thermal
		Thermal Transfer
	Tear-off Position	0-40
	Top of Form	Apply
		Cancel
		850
		852
		437
Setting		860
		863
		865
		857
		861
		862
		855
	Codepage	866
		737
		851
		869
		Win 1252
		Win 1250
		Win 1251
		Win 1253
		Win 1254
		Win 1255
		Win 1257



Label Setting

		0°
	Rotation	90°
		180°
		270°
	Horizontal offset	-100 - 100
	Vertical offset	-100 - 100
	Start offset	-100 - 100
	Recall Label	001 Form Name
		002 Form Name



Device

Buzzer		Apply
		Cancel
		None
Optional Setting	Option	Cutter
		Label Dispensor
		Applicator
	Pre-Printing	Apply
		Cancel
LAN Setting	Port No.	09100
	DHCP	Disable
		Enable
	Default Gateway	192.168.000.254
	Dynamic IP	192.168.102.076
	Subnet Mask	255.255.255.000
LCD Password		Disable
		Enable
Serial Port Setting	Baud Rate	4800 bps
		9600 bps
		19200 bps
		38400 bps
		57600 bps
		115200 bps
	Parity	Non
	Odd	
	Even	
Data bits	7 bits	
	8 bits	
Stop bits	1 bits	
	2 bits	
RTC Setting	Clock Display	Apply
		Cancel
	RTC Setting	YYYY/MM/DD
		HH:MM:SS
Bluetooth Setting	Clear Bind	Enable
		Disable
	Make Device Visible	Enable
		Disable
	SSP	Enable
	Disable	
	PIN Code	0000
	Search Devices	



Analysis

Calibration		Apply
		Cancel
Self-test		Apply
		Cancel
TPH Testing		Apply
		Cancel
Reset to Default		Apply
		Cancel
Clear Memory	Label Format	Apply
		Cancel
	Graphic	Apply
		Cancel
	Bitmap Fonts	Apply
		Cancel
	True Type Fonts	Apply
	Cancel	
Asian Fonts	Apply	
	Cancel	
ALL	Apply	
	Cancel	

EXIT



Exit

Exit





3.8 Status of LCD Interface (DT200i/DT200iL Series)

When printer is on standby status (ready to print), the LCD interface will display “Ready” on screen. You can only print on this “Ready” status.

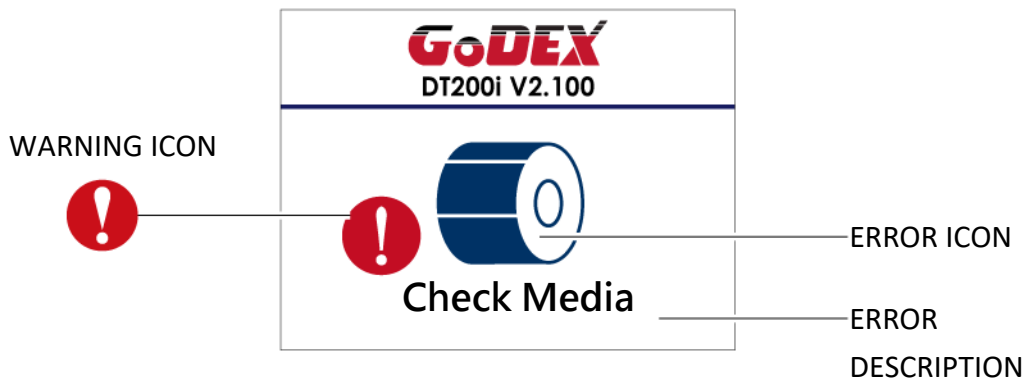

If there is any printers error, the LCD screen will display the error screen to show the type of error. You can fix the error according the notice.









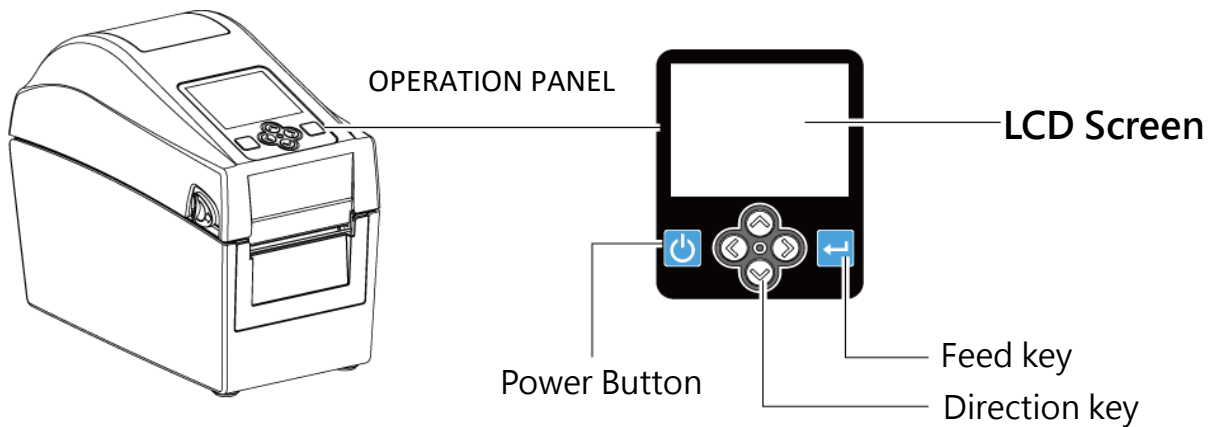

	To upper level	Appears on the NAVIGATION ICON of Setting Pages. It guides you back to upper level by pressing “LEFT” key.
	To upper level	Appears on the NAVIGATION ICON of Setting Value Pages. It guides you back to upper level by pressing “UP” key.
	Lock	On Setting Value pages, press “RIGHT” key to lock the value for preventing unexpected change.
	Unlock	For locked value, press “RIGHT” key again to unlock the value.
	Scroll the value	On Setting Value pages, press “UP” or “DOWN” key to scroll the values for your selection.

3.9 Error Alerts (DT200i/DT200iL Series)

In the event of a problem that prevents normal functioning of the printer, you will see an error message on LCD screen and hear some beep signals. Please refer to below table for the error alerts.



Operation Panel Status	Type	Beeps	Description	Solution
  TPH opened	Print head Error	2 x 4 beeps	The printing mechanism is not correctly closed.	Open the print mechanism and close it again.
  TPH overheat	Print head Error	None	High temperature at the print head.	Once the print head has cooled down, the printer switches to standby mode.
  Check ribbon setting	Media Error	2 x 3 beeps	No ribbon is installed and the printer displays an error.	Make sure that the printer is set to direct thermal printing mode.
  Check paper setting	Media Error	2 x 2 beeps	No paper is detected.	Make sure that the label sensor is positioned correctly. If the sensor still does not detect the paper, run the auto-detection function again.
			No paper is detected.	Replace the label roll.
			No paper is detected.	Possible reasons: the print medium has become trapped around the rubber roll; the sensor cannot detect a gap or black mark between the labels; there is no paper. Please reset the sensor.

**Operation Panel
Status**



Type

Beeps

Description

Solution

The memory is full. The printer prints the message "File System full".

Delete unnecessary data or install additional memory.



File Error 2 x 2 beeps

Unable to find file. The printer prints the message "File Name not found"

Use the "~X4" command to print all files. Then check whether the files exist and whether the names are correct.



A file of the same name already exists. The printer prints the message "Duplicate Name".

Change the name of the file and try storing it again.

3.10 USB Host

Definition : USB Host port supports either device : USB memory stick, keyboard or scanner.

Purpose

- USB memory stick : It extends the user memory space up to 32GB for Graphic, Font, Label Format, DBF and Command files downloading. The printer's Firmware also can be updating if copy new version of Firmware into USB memory stick.
- Connecting an USB keyboard to printer for " Standalone" mode operation.
- Plug-in an USB scanner to operate the printer in "Standalone" mode.

Usage of Extended Memory

- USB memory stick : It supports hot-plugging function; printer will create a Folder "\\LABELDIR" and switch "User Flash to " Extended Memory" automatically while user plugs an USB memory stick into a GoDEX "i" model printer.
- Connect the USB Stick plugged -in printer to PC via USB Device or Ethernet port and run "GoLabel" software to download Graphic, Font, Label Format, DBF and Command files to the printer.
- Detail download procedures, please refer to "GoLabel On-line Help".

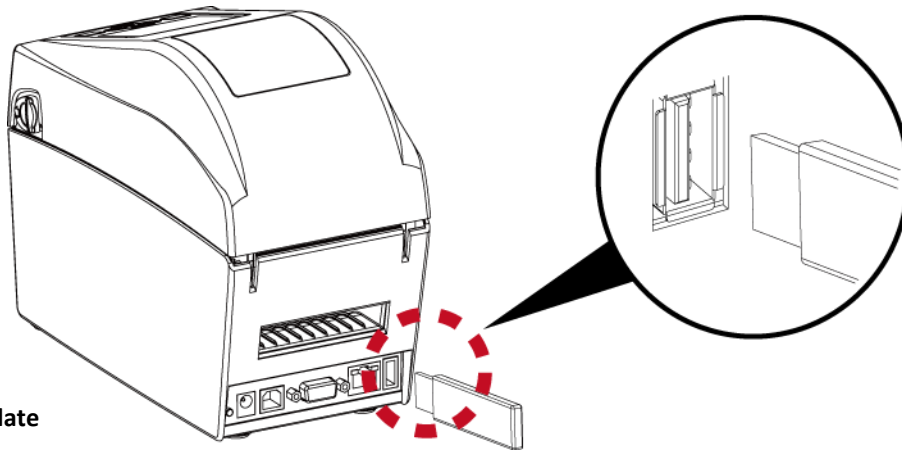

Usage of Firmware Update

- Remove USB memory stick from printer and plug-in it to a PC's USB port; delete Firmware "*.bin" file from "\\LABELDIR\FW" of USB memory stick if it existing; or create a Folder "\\LABELDIR\FW" to USB memory stick if it doesn't existing.
- Copy a new version of Firmware "xxxx.bin" to the Folder "\\LABELDIR\FW"; and then remove USB and plug-in back to the printer that going to update Firmware.
- The printer will update the Firmware automatically when plug-it-into the printer and printer find-out the Firmware in "\\LABELDIR\FW" is newer version.
- Don't remove the USB memory stick out while it's under updating with "Flash Writing..." message that displays on LCD panel.

USB Keyboard

- When plug-in an USB keyboard to the printer, LCD panel will display “Standalone Mode”, press the “Enter” key on keyboard and “Feed” key in the printer to entering to the dialog for “Recall Label” operation.

- Only the sub-dialog “Recall Label” is able operating by keyboard as follow definition:

1. Press “ESC” key to exist from “Standalone Mode” or back to previous dialog
2. Press “F1”, it will let the printer from “Ready” mode entering into “Standalone Mode”
3. Press “Enter”, “Arrow” and “Alphabetic” keys as the usual in PC that will perform the key-in function of “Recall Label” in “Standalone Mode”.

Scanner

- When plug-in an USB scanner to the printer, LCD panel will display “Standalone Mode”, press the “Feed” key in the printer to entering the dialog of “Recall Label” operation. User performs the “Recall Label” function interactively through the LCD panel, 4 direction keys, Feed key and Scanner.

- Scanner is using in “standalone Mode” to scanning the “Serial Number, Variable” and Print Quantity while the printer prompts a message on LCD panel and wait for data input.

4. NetSetting for Ethernet

4.1 Installing the NetSetting software

The NetSetting software is used to manage the network configurations when connecting the printer via Ethernet port. It is available on product CD or can be downloaded from official website. To install the NetSetting, please follow below steps.

1. Select the icon for the NetSetting installation file and click it to start the installation.

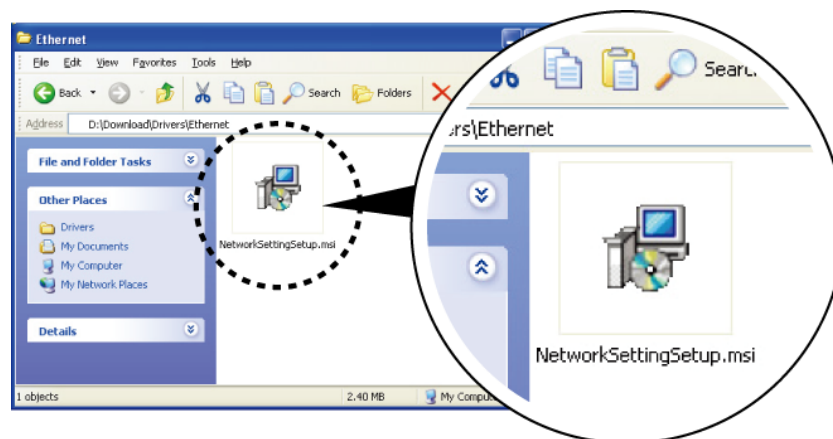

2. Follow the instructions on the screen. The Setup Wizard guides you through the installation procedure.
3. Specify the "Installation Folder".

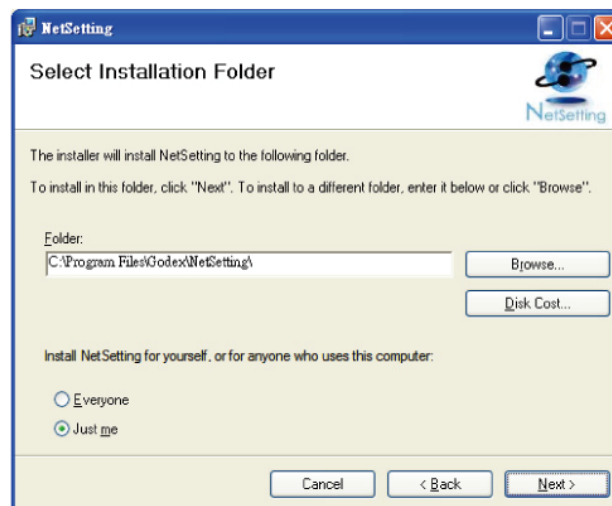

4. Click "Next" to start the installation.
5. Once the installation is completed; you will see the NetSetting icon on your desktop.



4.2 The Interface of NetSetting

Click the NetSetting icon to start the program; you will see the start page as below. The start page will display the basic information of connected printer and your PC.

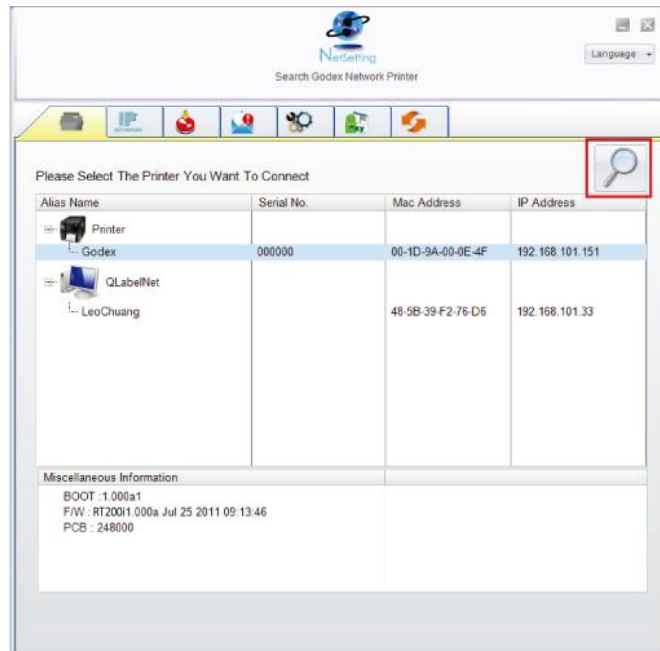

Click the magnifier icon to search the Godex printers which are connected via Ethernet port in you network environment. Once a connected Godex printer is detected, it will be listed on the start page.

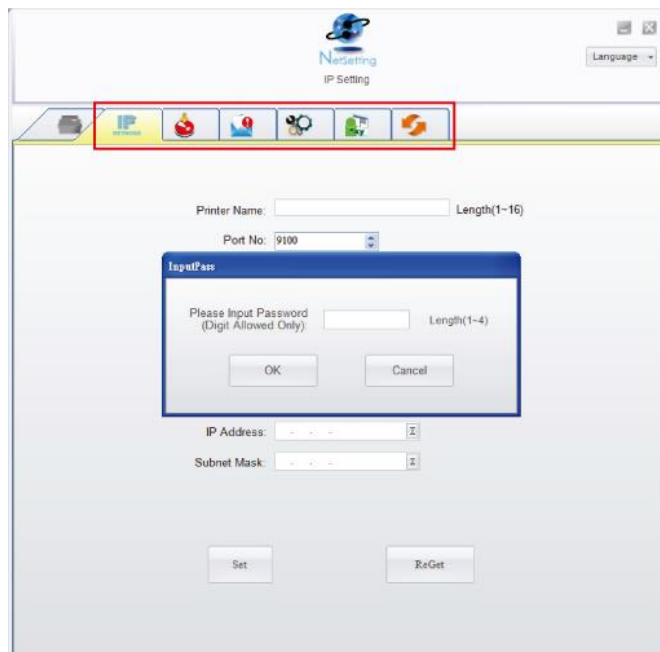

There are six tabs on the top of interface which can configure different types of network settings. But for the data security reason, you need correct password to enter the configuration pages.

Notice The default password is "1111", you can change the password later from the "IP Setting" tab.

IP Setting

The IP Setting tab can change the printer name, Port number, Gateway setting and the password for configuring the printer. You can also set the printer's IP address either by DHCP or by Static IP.

The screenshot shows the 'NetSetting IP Setting' window. The title bar includes the 'NetSetting' logo and 'IP Setting' text, along with a 'Language' dropdown menu. The main content area features the following fields and controls:

- Printer Name: Length(1~16)
- Port No:
- Default Gateway: I
- Password: Length(1~4)
- Get IP From DHCP Server
- Static IP
- IP Address: I
- Subnet Mask: I

At the bottom of the window, there are two buttons: 'Set' and 'ReGet'.

You can press "Set" button to apply the settings and "ReGet" button to refresh the setting values.

Notice To fully benefit from the NetSetting software, you should be familiar with basic networking principles. Please contact your network administrator for related network setting information.

Alert Path Setting

NetSetting will send the alert messages to designated mail account when the error happened on printer. The alert messages are sent by SMTP (Simple Mail Transfer Protocol) or SNMP (Simple Network Management Protocol).

You can set or change the configurations of SMTP and SNMP on this “Alert Path Setting” tab.

The screenshot shows the 'Alert Path Setting' window in NetSetting. The window title is 'Alert Path Setting' and it has a 'Language' dropdown menu. Below the title bar is a navigation bar with icons for printer, IP, alarm, mail, settings, and refresh. The main content area is divided into two sections: 'SMTP Notification Enable' and 'SNMP Notification Enable'. The SMTP section includes fields for Login Account (fault), Login Password (*****), Server IP Address (0.1.66.97), Mail Subject (rcode printer message), Mail From Address (fault@default.com), Mail To Address (fault@default.com), Duration Cycle (0), and Event Counter (1). The SNMP section includes fields for SNMP Community (16 empty boxes), SNMP Trap Community (blie), and Trap IP Address (0.1.255.0). At the bottom are 'Set' and 'ReGet' buttons.

You can press “Set” button to apply the settings and “ReGet” button to refresh the setting values.

Alert Message Setting

For the alert message notification function, you can decide which error cases need to be sent out to the operator. Moreover, the alert messages can be set to be sent by SMTP, SNMP or both.

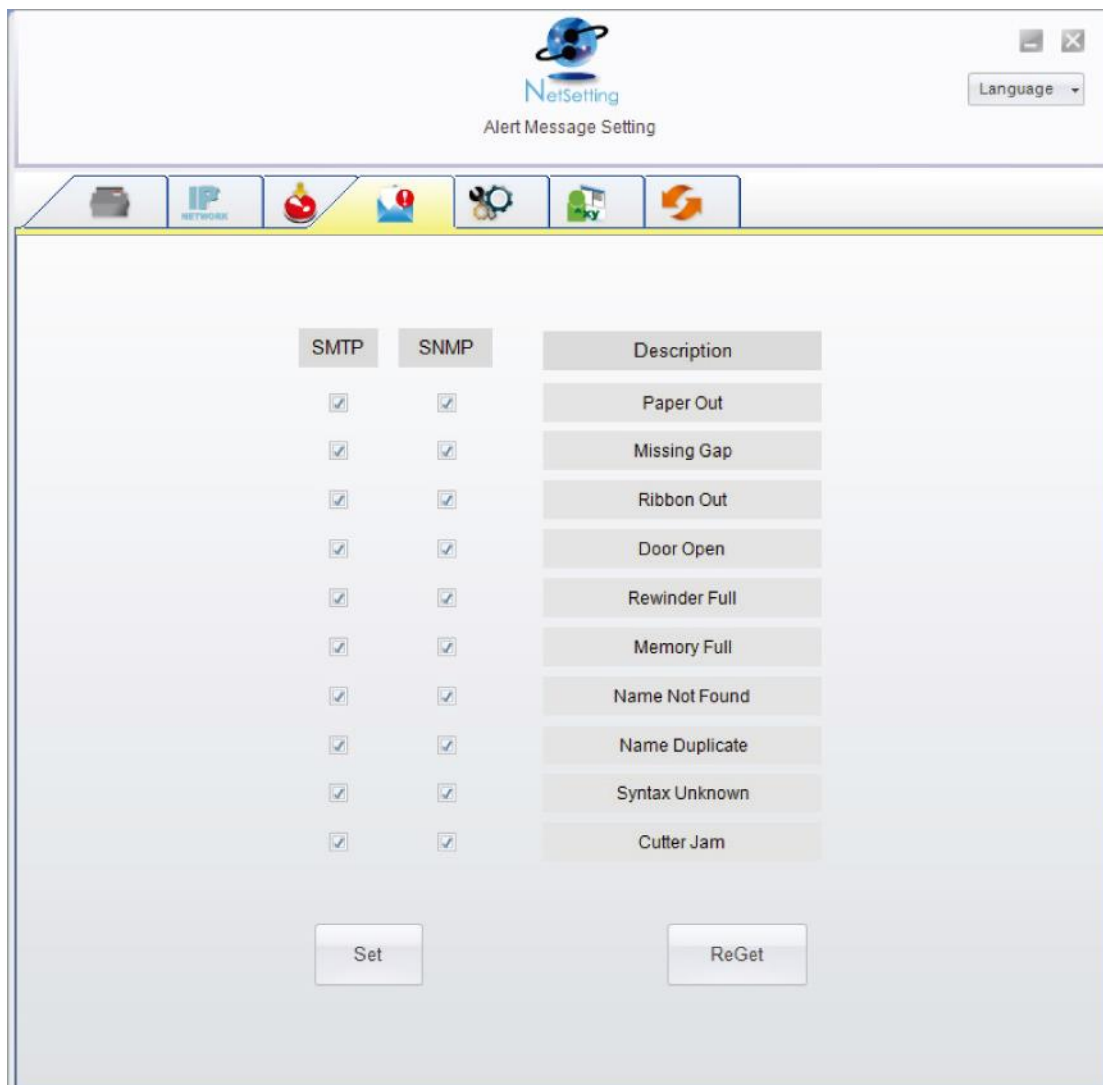

You can press “Set” button to apply the settings and “ReGet” button to refresh the setting values.

Printer Configuration

Set or change the configurations of connected printer. Most of key settings for the printer operation can be done by this setting page.

The screenshot shows the 'Printer Configuration' window from NetSetting. The window title is 'Printer Configuration' and it has a 'Language' dropdown menu in the top right corner. Below the title bar is a navigation bar with several icons. The main content area is titled 'Printer Setup' and contains the following settings:

Printer Model	Resolution	Speed	Darkness	Stripper/Applicator	Labels per Cut	Printing Mode
DT200	203	4	10	0 (None)	0	Thermal Transf

Below the 'Printer Setup' section are two sub-sections:

- PC Com Port Settings:**
 - Baud Rate: 9600
 - Parity: None
 - Data Bits: 8
 - Stop Bits: 1
- Miscellaneous:**
 - LCD Language: (empty)
 - Keyboard Language: (empty)
 - Code Page: Code Page 850
 - Buzzer: ON
 - Sensing Mode: 2 - Automatic
 - Smart Backfeed: OFF
 - Top Of Form: ON

At the bottom of the window are two buttons: 'Set' and 'ReGet'.

You can press "Set" button to apply the settings and "ReGet" button to refresh the setting values.

User Command

The "User Command" tab provides a communication interface for operator to control the printer. Input printer commands in "Input Command" window and press "Send Command" button, the commands will be sent to the printer.

For some commands that will return response message, the message will be displayed in "Output Message" window.

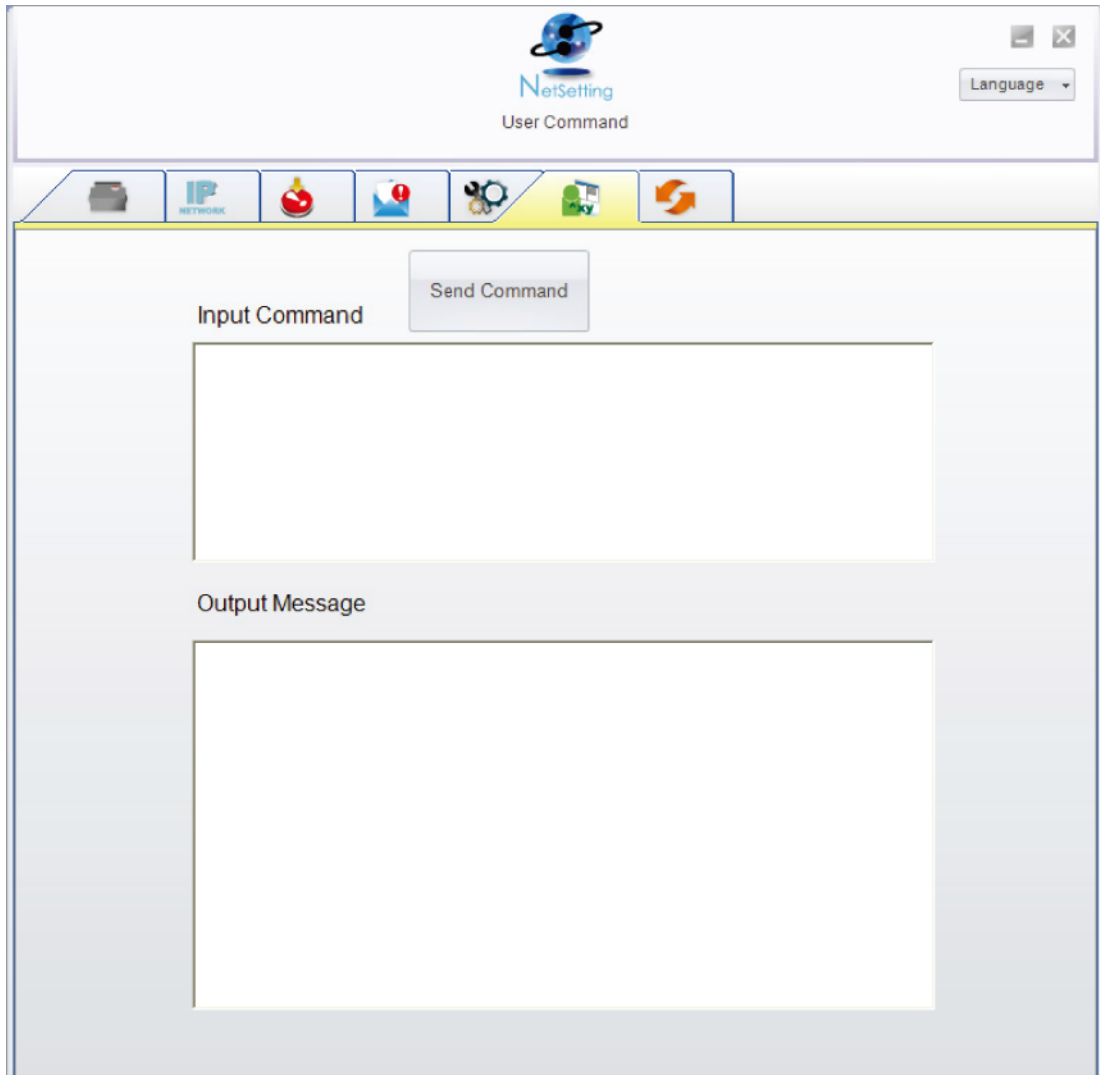

You can press "Send Command" button to send printer commands via Ethernet port and control the printer remotely.

Firmware Download

On “Firmware Download” tab, the current version of printer firmware will be showed on the screen. If you need to update the printer firmware, just specify the file location of firmware file and press “Start Download Firmware” button. The printer firmware then can be updated remotely.

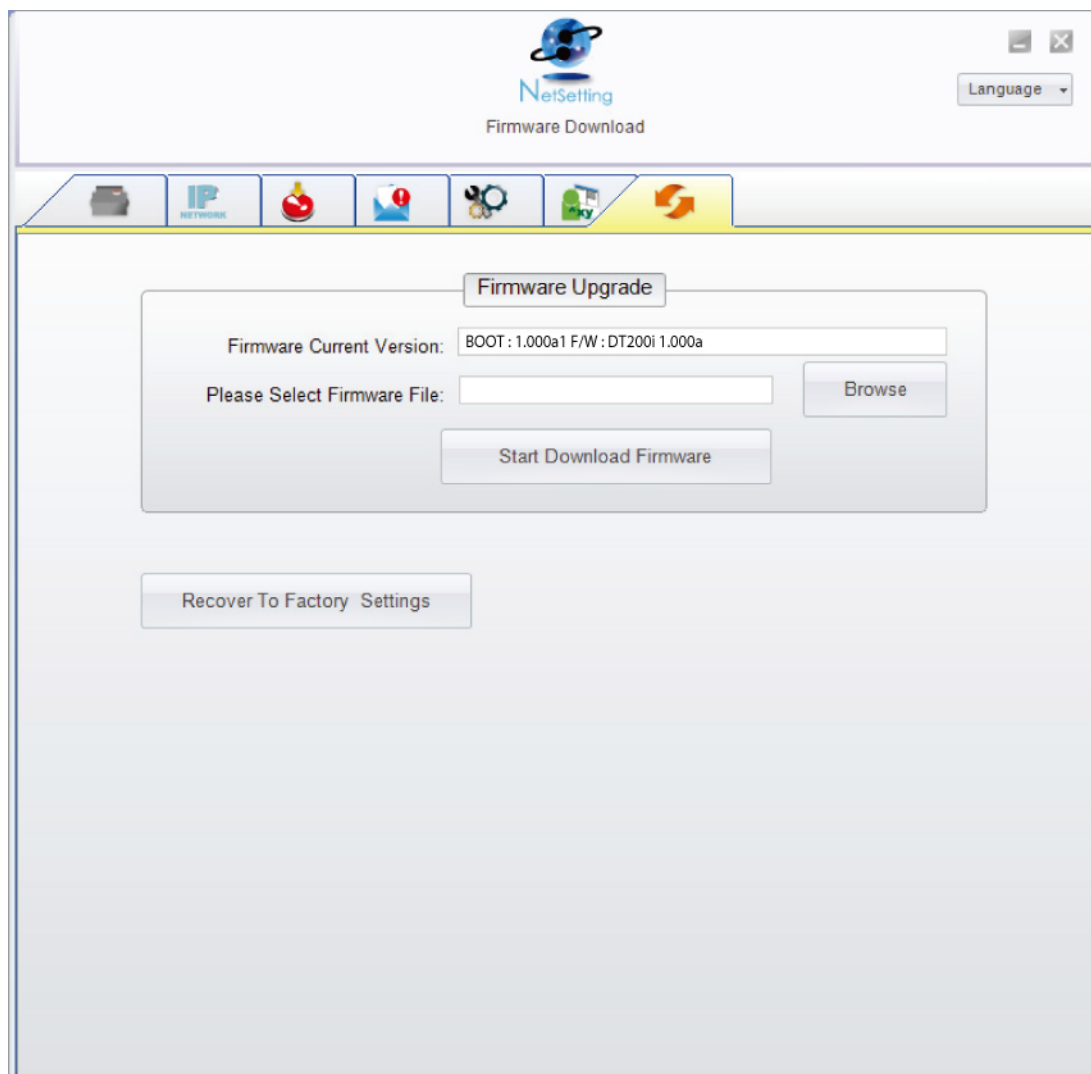

In addition to the firmware update, you can press “Recover To Factory Settings” button to restore the printer configurations back to factory default.

5. Maintenance and Adjustment

5.1 Cleaning the Print Head

Dirt on the print head or ribbon, or glue residue from the label stock may result in inadequate print quality. The printer cover must therefore always be closed during printing. Keeping dirt and dust away from the paper or labels ensures a good print quality and a longer lifespan of the print head.

Cleaning Steps

Here is how you clean the print head.

1. Turn off the printer.
2. Open the printer cover.
3. Remove the ribbon.
4. To remove any label residue or other dirt from the print head (see red arrow), please use a soft lint-free cloth dipped in alcohol.

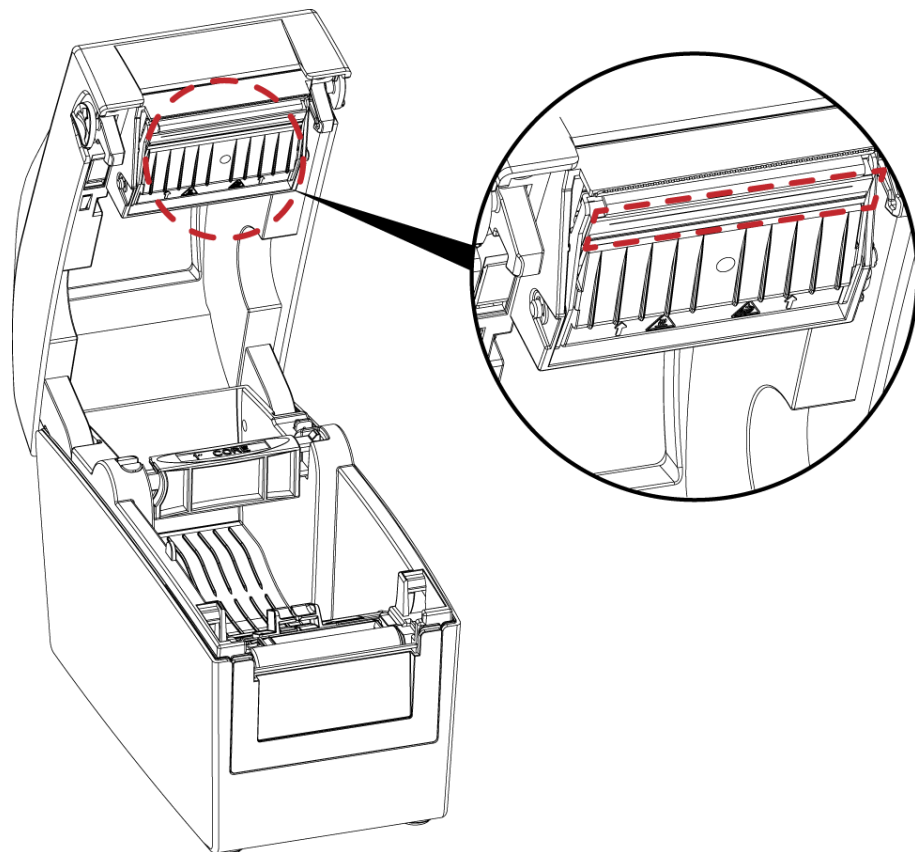

Notice

* The print head should be cleaned once a week.

* Please make sure that there are no metal fragments or other hard particles on the soft cloth used to clean the print head.

5.2 Troubleshooting

Problem	Solution
The printer is switched on but the LCD screen does not light up.	<ul style="list-style-type: none"> ● Check the power supply.
The LCD screen show the notice icon and printing is interrupted.	<ul style="list-style-type: none"> ● Check the software settings (driver settings) or command codes. ● Look for the error alert in the table in Section 3.9. Error Alerts. ● Check whether the print mechanism is closed correctly.
The label stock passes through the printer but no image is printed.	<ul style="list-style-type: none"> ● Choose the correct printer driver. ● Choose the correct label stock and a suitable printing mode.
The label stock jams during printing.	<ul style="list-style-type: none"> ● Clear the paper jam. Remove any label material left on the thermal print head and clean the print head using a soft lint-free cloth dipped in alcohol.
There is no printed image on some parts of the label.	<ul style="list-style-type: none"> ● Check whether any label material or ribbon is stuck to the thermal print head. ● Check for errors in the application software. ● Check whether the starting position has been set incorrectly. ● Check the ribbon for wrinkles.
There is no printed image on part of the label or the image is blurred.	<ul style="list-style-type: none"> ● Check the thermal print head for dust or other dirt. ● Use the internal “~T” command to check whether the thermal print head will carry out a complete print job. ● Check the quality of the print medium.
The printed image is positioned incorrectly.	<ul style="list-style-type: none"> ● Check whether there is paper or dust covering the sensor. ● Check whether the label stock is suitable. Contact your supplier. ● Check the paper guide settings.
A label is missed out during printing.	<ul style="list-style-type: none"> ● Check the label height setting. ● Check whether there is dust covering the sensor. ● Run the auto-detection function.
The printed image is blurred.	<ul style="list-style-type: none"> ● Check the darkness setting. ● Check the thermal print head for dust or dirt. <p>Please see the Section 5.1</p>
The cutter does not cut off the labels in a straight line.	<ul style="list-style-type: none"> ● Check whether the label stock is positioned straight.
The cutter does not cut off the labels completely.	<ul style="list-style-type: none"> ● Check whether the label is more than 0.2 mm thick
When using the cutter, the labels are not fed through or cut off incorrectly.	<ul style="list-style-type: none"> ● Check whether the cutter has been correctly installed. ● Check whether the paper guides are functioning correctly.
The label dispenser is not functioning normally.	<ul style="list-style-type: none"> ● Check whether there is dust on the label dispenser. ● Check whether the label stock is positioned correctly.

Appendix

DT200 series Printer Specification

Model		DT200	DT230	DT200i	DT230i
Print Method		Direct Thermal			
Resolution		203 dpi (8 dots/mm)	300 dpi (12 dots/mm)	203 dpi (8 dots/mm)	300 dpi (12 dots/mm)
Print Speed		7 IPS (178 mm/s)	5 IPS (127 mm/s)	7 IPS (178 mm/s)	5 IPS (127 mm/s)
Print Width		2.12" (54 mm)	2.24" (57 mm)	2.12" (54 mm)	2.24" (57 mm)
Print Length		Min. 0.16" (4 mm)**; Max. 68" (1727 mm)	Min. 0.16" (4 mm)** ; Max. 30"(762 mm)	Min. 0.16" (4 mm)**; Max. 68" (1727 mm)	Min. 0.16" (4 mm)** ; Max. 30"(762 mm)
Processor		32 Bit RISC CPU			
Memory	Flash	128 MB Flash (60 MB for user storage)			
	SDRAM	32 MB			
Sensor Type		Adjustable reflective sensor (half range). Fixed transmissive sensor. Central aligned.			
Media	Types	Continuous form, gap labels, black mark sensing, and punched hole; label length set by auto sensing or programming			
	Width	Min. 0.6" (15 mm) – Max. 2.36" (60 mm)			
	Thickness	0.003" (0.08 mm) Min. - 0.008" (0.20 mm) Max.			
	Label Roll Diameter	Max. 5" (127 mm)			
	Core Diameter	1" (25.4 mm), 1.5" (38.1 mm)			
Printer Language		EZPL, GEPL, GZPL, GDPL auto switch			
Software	Label Design Software	GoLabel (for EZPL only)			
	Driver SDK	Vista, Windows 7, Windows 8 & 8.1, Windows 10, Windows Server 2008 R2, 2012, 2012 R2, 2016, 2019, MAC, Linux Win CE, .NET, Windows Vista, Windows 7, Windows 8 & 8.1, Windows 10, Android, Mac, iOS			
Resident Fonts	Bitmap Fonts	6, 8, 10, 12, 14, 18, 24, 30, 16X26 and OCR A&B Bitmap fonts 0°, 90°, 180°, 270° rotatable, single characters 0°, 90°, 180°, 270° rotatable Bitmap fonts 8 times expandable in horizontal and vertical directions			
	TTF Fonts	TTF Fonts (Bold / Italic / Underline). 0°,90°, 180°, 270° rotatable			
Download Fonts	Bitmap Fonts	0°, 90°, 180°, 270° rotatable, single characters 0°, 90°, 180°, 270° rotatable 6x16, 24x24. Traditional Chinese (BIG-5), Simplified Chinese(GB2312), Japanese (S-JIS), Korean (KS-X1001)			
	Asian Fonts	0°, 90°, 180°, 270° rotatable and 8 times expandable in horizontal and vertical directions			
Barcodes	TTF Fonts	TTF Fonts (Bold / Italic / Underline). 0°,90°, 180°, 270° rotatable			
	1-D Bar codes	China Postal Code, Codabar, Code 11, Code 32,Code 39, Code 93, Code 128 (subset A, B, C), EAN-8/EAN-13 (with 2 & 5 digits extension), EAN 128, FIM, German Post Code, GS1 DataBar, HIBC, Industrial 2 of 5 , Interleaved 2-of-5 (I 2 of 5), Interleaved 2-of-5 with Shipping Bearer Bars, ISBT-128, ITF 14, Japanese Postnet, Logmars, MSI, Postnet, Plessey, Planet 11 & 13 digit, RPS 128, Standard 2 of 5, Telepen, Matrix 2 of 5, UPC-A/UPC-E (with 2 or 5 digit extension), UCC/EAN-128 K-Mart and Random Weight			
	2-D Bar codes	Aztec code, Code 49,Codablock F , Datamatrix code, MaxiCode, Micro PDF417, Micro QR code, PDF417,QR code, TLC 39, GS1 Composite			
Code Pages		Codepage 437, 737,850, 851, 852, 855, 857, 860, 861, 862, 863, 865, 866, 869 Windows 1250, 1251, 1252, 1253, 1254, 1255, 1257 Unicode UTF8 · UTF16BE · UTF16LE			
Graphics		Resident graphic file types are BMP and PCX, other graphic formats are downloadable from the software			
Interfaces		USB 2.0		USB 2.0	
		Serial port: RS-232 (DB-9) Ethernet 10/100 Mbps		Serial port: RS-232 (DB-9) Ethernet 10/100 Mbps USB Host (A-Type)	
Control Panel		Two LEDs : Ready, Status Power on / off button Calibration button Control key : FEED		Color TFT LCD with navigation button Power on/off button Calibration button Control key: FEED	
Real Time Clock		Option			Standard
Power		Switching power 100-240VAC, 50-60Hz input			
Environment	Operation Temperature	41°F to 104°F (5°C to 40°C)			
	Storage Temperature	-4°F to 122°F (-20°C to 50°C)			
Humidity	Operation	30-85%, non-condensing			
	Storage	10-90%, non-condensing			
Agency Approvals		CE (EMC) · FCC Class B · CB · UL · cUL · CCC · BSMI			
Dimension	Length	206 mm (8.11")			
	Height	174 mm (6.85")			
	Width	110 mm (4.33")			
Weight		1.0 kg, exclusive consumables			
Options		Cutter		Cutter	
		Label Dispenser		Label Dispenser	
		External label unwind Stand		External label unwind Stand	
		External label rewinder		External label rewinder	
		Bluetooth		Bluetooth	
		Wireless LAN (IEEE 802.11 b/g/n) Real Time Clock (RTC)		Wireless LAN (IEEE 802.11 b/g/n)	

*Specifications are subject to change without notice. All company and/or product names are trademarks and/or registered trademarks of their respective owners.

**Minimum print height and maximum print speed specification compliance can be dependent on non-standard material variables such as label type, thickness, spacing, liner construction, etc. GoDEX is pleased to test non-standard materials for minimum print height, and maximum print speed capability.

***The cutter is an optional accessory. If the cutter is installed,it is not suitable for children to approach.

DT200 series Printer Specification

Model		DT200L	DT230L	DT200iL	DT230iL
Print Method		Direct Thermal			
Resolution		203 dpi (8 dots/mm)	300 dpi (12 dots/mm)	203 dpi (8 dots/mm)	300 dpi (12 dots/mm)
Print Speed		6 IPS (152 mm/s)	4 IPS (102 mm/s)	6 IPS (152 mm/s)	4 IPS (102 mm/s)
Print Width		2.12" (54 mm)	2.24" (57 mm)	2.12" (54 mm)	2.24" (57 mm)
Print Length	With Cutter	Min. 1.57" (40 mm)**; Max. 6.3" (160 mm)			
	Without Cutter	Min. 1.57" (40 mm)**; Max. 4.72" (120 mm)			
Processor		32 Bit RISC CPU			
Memory	Flash	128 MB Flash (60 MB for user storage)			
	SDRAM	32 MB			
Sensor Type		Adjustable reflective sensor (half range). Fixed transmissive sensor. Central aligned.			
Media	Types	Continuous linerless label; label length set by auto sensing or programming			
	Width	Min. 0.6" (15 mm) – Max. 2.36" (60 mm)			
	Thickness	0.003" (0.08 mm) Min. - 0.004" (0.10 mm) Max.			
	Label Roll Diameter Core Diameter	Max. 5" (127 mm) 1" (25.4 mm), 1.5" (38.1 mm)			
Printer Language		EZPL, GEPL, GZPL, GDPL auto switch			
Software	Label Design Software	GoLabel (for EZPL only)			
	Driver SDK	Vista, Windows 7, Windows 8 & 8.1, Windows 10, Windows Server 2008 R2, 2012, 2012 R2, 2016, 2019, MAC, Linux Win CE, .NET, Windows Vista, Windows 7, Windows 8 & 8.1, Windows 10, Android, Mac, iOS			
Resident Fonts	Bitmap Fonts	6, 8, 10, 12, 14, 18, 24, 30, 16X26 and OCR A&B Bitmap fonts 0°, 90°, 180°, 270° rotatable, single characters 0°, 90°, 180°, 270° rotatable Bitmap fonts 8 times expandable in horizontal and vertical directions			
	TTF Fonts	TTF Fonts (Bold / Italic / Underline). 0°, 90°, 180°, 270° rotatable			
Download Fonts	Bitmap Fonts	0°, 90°, 180°, 270° rotatable, single characters 0°, 90°, 180°, 270° rotatable			
	Asian Fonts	6x16, 24x24. Traditional Chinese (BIG-5), Simplified Chinese (GB2312), Japanese (S-JIS), Korean (KS-X1001) 0°, 90°, 180°, 270° rotatable and 8 times expandable in horizontal and vertical directions			
Barcodes	1-D Bar codes	TTF Fonts (Bold / Italic / Underline). 0°, 90°, 180°, 270° rotatable China Postal Code, Codabar, Code 11, Code 32, Code 39, Code 93, Code 128 (subset A, B, C), EAN-8/EAN-13 (with 2 & 5 digits extension), EAN 128, FIM, German Post Code, GS1 DataBar, HIBC, Industrial 2 of 5, Interleaved 2-of-5 (I 2 of 5), Interleaved 2-of-5 with Shipping Bearer Bars, ISBT-128, ITF 14, Japanese Postnet, Logmars, MSI, Postnet, Plessey, Planet 11 & 13 digit, RPS 128, Standard 2 of 5, Telepen, Matrix 2 of 5, UPC-A/UPC-E (with 2 or 5 digit extension), UCC/EAN-128 K-Mart and Random Weight			
	2-D Bar codes	Aztec code, Code 49, Codablock F, Datamatrix code, MaxiCode, Micro PDF417, Micro QR code, PDF417, QR code, TLC 39, GS1 Composite			
Code Pages		Codepage 437, 737, 850, 851, 852, 855, 857, 860, 861, 862, 863, 865, 866, 869 Windows 1250, 1251, 1252, 1253, 1254, 1255, 1257 Unicode UTF8 · UTF16BE · UTF16LE			
Graphics		Resident graphic file types are BMP and PCX, other graphic formats are downloadable from the software			
Interfaces	USB 2.0		USB 2.0		
	Serial port: RS-232 (DB-9) Ethernet 10/100 Mbps		Serial port: RS-232 (DB-9) Ethernet 10/100 Mbps USB Host (A-Type)		
Control Panel		Two LEDs : Ready, Status Power on / off button Calibration button Control key : FEED		Color TFT LCD with navigation button Power on/off button Calibration button Control key: FEED	
Real Time Clock		Option		Standard	
Power		Switching power 100-240VAC, 50-60Hz input			
Environment	Operation Temperature	41°F to 104°F (5°C to 40°C)			
	Storage Temperature	-4°F to 122°F (-20°C to 50°C)			
Humidity	Operation	30-85%, non-condensing			
	Storage	10-90%, non-condensing			
Agency Approvals		CE (EMC) · FCC Class B · CB · UL · cUL · CCC · BSMI			
Dimension	Length	With Cutter	270 mm (10.6")		
		W/O Cutter	218 mm (8.58")		
	Height Width	174 mm (6.85") 110 mm (4.33")			
Weight		1.5 kg, exclusive consumables			
Options	Linerless Cutter		Linerless Cutter		
	Bluetooth		Bluetooth		
	Wireless LAN (IEEE 802.11 b/g/n)		Wireless LAN (IEEE 802.11 b/g/n)		
	Real Time Clock (RTC)				

*Specifications are subject to change without notice. All company and/or product names are trademarks and/or registered trademarks of their respective owners.

**Minimum print height and maximum print speed specification compliance can be dependent on non-standard material variables such as label type, thickness, spacing, liner construction, etc. GoDEX is pleased to test non-standard materials for minimum print height, and maximum print speed capability.

***The cutter is an optional accessory. If the cutter is installed, it is not suitable for children to approach.

Interface

Pinout Description

- USB

Connector Type : Type B

Pin NO.	1	2	3	4
Function	VBUS	D-	D+	GND

- Serial port

Default settings : Baud rate 9600, no parity, 8 data bits, 1 stop bit, XON/XOFF protocol and RTS/CTS

RS232 Housing(9-pin to 9-pin)

DB9 Socket		DB9 Plug
-		+5V, max 500mA
RXD	1_____1	TXD
TXD	2_____2	RXD
DTR	3_____3	N/C
GND	4_____4	GND
DSR	5_____5	RTS
RTS	6_____6	CTS
CTS	7_____7	RTS
RI	8_____8	N/C
Computer	9_____9	Printer

- Ethernet

Type:RJ45

Pin NO.	1	2	3	4	5	6	7	8
	TX+	TX-	RX+	NC	NC	RX-	NC	NC

- USB host

Connector Type : Type A

Pin NO.	1	2	3	4
	VBUS	D-	D+	GND

File Mainpulation When Using USB Stick

File Manipulation

The files in both devices (USB memory stick and printer internal Flash memory) are able to copy and move by the commands “~MCPY” and “MMOV” that sends from GoLabel on a PC via either connection - USB or Ethernet ports.

● Copy

Syntax	~MCPY,s:o.x,d:o.x
Parameter	s = source device of stored object (s = D (for USB memory stick) or F (for internal Flash memory)) d = destination device of stored object o = object name , the name "o" is substituted for "*" x = extension (file type), the type "x" is substituted by "*", or following either one: D= database, A= Asia font, C= TTF font, E= Bit-Mapped font, F= label format, G= graphic, S= serial file, T= text, B= Unicode Table.
Description	Copy file from USB memory stick to Flash memory, or vise-versa
Example	~MCPY,F:*.F,D:*.F (Copy entire "Label Format" files from Flash memory to USB memorystick) ~MCPY,D:*.G,F:*.G (Copy entire "Graphic" files from USB memory stick to Flash Memory) ~MCPY,D:*.*,F:*. * (Copy all object files from USB memory stick to Flash Memory)

● Move

Syntax	~MMOV,s:o.x,d:o.x
Parameter	s = source device of stored object; <ul style="list-style-type: none"> ● "D" for USB memory stick; "F" for internal Flash memory d = destination device of stored object <ul style="list-style-type: none"> ● "D" for USB memory stick; "F" for internal Flash memory o = object name (file name); the name "o" is substituted for "*" x = extension (file type), the type "x" is substituted by "*", or following either one: D= database, A= Asia font, C= TTF font, E= Bit-Mapped font, F= label format, G= graphic, S= serial file, T= text, B= Unicode Table.
Description	Move files from USB memory stick to Flash memory or vise-versa
Example	~MMOV,F:*.F,D:*.F (Move entire "Label Format" files from Flash memory to USB memorystick) ~MMOV,D:*.G,F:*.G (Move entire "Graphic" files from USB memory stick to Flash Memory) ~MMOV,D:*.*,F:*. * (Move all object files from USB memory stick to Flash Memory)